

# M3000 Marine Motors

ABB LV Motors M3000 Range





## Making you more Competitive

ABB LV Motors knows about customer needs. For over 100 years we have been designing motors for every need and application. With a reputation for quality that is second to none, our offering is further complemented by our 24-hour availability, unsurpassed reliability and leading technology evident in our eBusiness solutions. For top performance and high efficiency motors combined with a unique and complete service offering, customers continually choose the ABB brand. From the most demanding industries to standard applications, our customers can rest assured that their needs are being met.

# M3000

## M3000 Range

Sometimes needs can be highly demanding. For those occasions, it's reassuring to know you can count on the highest quality motors, customized to fit your individual needs. Our unique M3000 range offers eff1 motors for the highest efficiency levels, bringing you environmental and economical savings. Thanks to our extended support and services such as eBusiness solutions, we also provide you with easy ordering and quick delivery. And our engineering support team offers a unique opportunity to receive product consultation from the people who designed these motors especially for you.

# M3000 Totally enclosed squirrel cage three phase motors for marine environment

Aluminium motors, sizes 56-250

Steel motors, sizes 280-400

Cast iron motors, sizes 71-400

Open drip proof motors IP 23 S, sizes 250-400

Contents	Page
<b>General</b>	
ABB LV motors for marine environments	4
<b>Mechanical design</b>	
Technical features	5
Mechanical design	6
<b>Electrical motors in Essential and Non-Essential Services</b>	8
<b>Ordering information</b>	9
<b>Data tables</b>	
Motors with aluminium and steel frame, single speed	10
Motors with aluminium and steel frame, two-speed	18
Motors with cast iron frame, single speed	28
Motors with cast iron frame, two-speed	36
Open drip proof motors IP 23 S, single speed	44
<b>Dimension drawings</b>	48
<b>Variant codes</b>	50
<b>ABB LV motors product range</b>	54
<b>Visit our web-site</b>	55

During the transition period some motor types belonging to M3000 range still have the old product codes and type designations. Always check the valid code before ordering.

ABB reserves the right to change the design, technical specification and dimensions without prior notice.

# ABB LV motors for marine environments

ABB complies with all the specifications required by shipowners, shipyards and manufacturers of shipbased products such as fans, pumps and compressors, hydraulics, lifting and cargo systems

where heavy duty performance, cost saving and reliability is paramount.

Design	IECPubl.34-1
Types of enclosure	IECPubl.34-5
Cooling methods	IECPubl.34-6
Mounting arrangements	IECPubl.34-7

Insulation	IECPubl. 85
Inspection and testing	IECPubl. 34-1 and 34-2
Balancing	IECPubl. 34-14
Electrical installation in ships	IECPubl. 92-301

## Internationally approved

“Unrestricted service” motors in accordance with the requirements of all major classification societies.

Standard motors
IEC Publ. 34-series, 72, 79 and 85
VDE 0530
DIN
BS 4999, 5000-series
SFS
SEN
CENELEC

Marine motors	Variant code
<b>ABS</b> American Bureau of Shipping	027
<b>BV</b> Bureau Veritas	024, 496
<b>CCS</b> China Classification Societies	483, 493
<b>CR</b> China Corp. Register of Ship.	485, 495
<b>DNV</b> Det Norske Veritas	025, 186
<b>GL</b> Germanischer Lloyd	049
<b>KR</b> Korean Register of Shipping	484, 494
<b>LR</b> Lloyd's Register of Shipping	026, 096
<b>NK</b> Nippon Kaiji Kyokai	481, 491
<b>RINA</b> Registro Italiano Navale	050, 492
<b>RS</b> Russian Maritime R. of Ship.	051, 497

## ABB LV Motors' comprehensive product range for marine applications includes:

**Three phase motors:** Totally enclosed IP 55 and open drip proof IP 23 S, squirrel cage.

**Two-speed motors** for fan and pump drives and constant torque.

**Ex-motors for hazardous environments:** Non-sparking, increased safety and flameproof according to EN 50014 - 50019, 50021. For more information see product catalogue 'M3000 Motors for Hazardous Environments'.

**Motors for open deck mounting:** IP 56, with or without fan and cover.

**Variable Speed Drive compatibility:** Optimised performance in VSD applications based on leading frequency converter technology within the ABB.

**Special designs:** In addition to an extensive range of modifications on standard types, customised motors can also be manufactured, especially in the field of special drive applications.

# Technical features

## High efficiency

Our motors are designed for the highest possible efficiency aimed to save energy and operation costs during the whole lifetime of the motor. Extra high efficiency on request.

## Low noise level

An important objective in the motor design is to minimize the noise level. And we have been successful. For more information see the Motor Guide or our web site.

## Electrical protection

Thermistors (PTC) are fitted as a standard in the windings of motors with frame sizes 160-400, to protect against overheating.

## Voltage ranges for extra versatility

A wide range of voltages up to 690 V for 50 Hz and 60 Hz available.

## Permissible temperature rise

Classification societies and standards	Ambient temperature °C	Permissible temperature rise in K for stator windings insulation class	
		B	F
IEC Publ. 34-1	40	80	105
IEC 92-301 <sup>1)</sup>	50	70	90
ABS	50	70	95
BV	45	75	100
CCS	45	75	95
CR	45	75	95
DNV	45	70 / 75 <sup>3)</sup>	95 / 100 <sup>3)</sup>
GL	45	75	100
KR	50	70	90
LR	45	70	95
NK	45 <sup>2)</sup>	75	100
RINA	45	75	95
RS	45	75	95

<sup>1)</sup> Electrical installation in ships

<sup>2)</sup> EEx motors: required ambient temperature = 50°C. Permissible temperature rise B-class = 70 K, F-class = 95 K.

<sup>3)</sup> From 2002.

## Tropic-resistant windings

All windings are tropicalized, i.e. insensitive to moisture and micro-organisms.

## Strong corrosion protection

The motors are made to withstand aggressive environments. They have strong and effective protection against corrosion.

## Reliable windings

To ensure long lifetime, the winding is made from the latest available material in class F protection and temperature rise 90 K according to the classification societies' rules.

If lower temperature rise, i.e. class B (70 K) is needed, it is necessary to reduce the rated output. As an indication the following formula can be used

$$P2 = P1 \times \sqrt{\frac{70}{\Delta t}}$$

P1 = output according to catalogue value

P2 = new output according to class B rise (70 K)

$\Delta t$  = actual temperature rise, normally 90 K

## Bearings with high load capacity

All motors are provided with deep-groove ball bearings as standard which are designed for 40,000 hours lifetime at normal duties and load capability. For motors with regreasing possibility, the lifetime is extended. Aluminium motors in sizes 56-180 and cast iron motors in sizes 71-132 are greased for life. Aluminium motors in sizes 200-250, cast iron motors in sizes 160-400 and all steel motors have a regreasing device as standard.

# Mechanical design

## Aluminium motors, totally enclosed fan cooled IP 55

Basic design manufactured from extra corrosion resistant aluminium alloy with low copper content with the following exceptions: Sizes 250-2 SMA, basic version, has cast iron feet and size 250-2 SMB, high output version, has cast iron feet and bearing shield. The flange bearing shields of sizes 180-250 are made of cast iron. Sizes 90-250 have drain holes and plugs as standard. See catalogue BA/M3AA GB and BA/M2VA GB for details.

## Steel motors, totally enclosed fan cooled IP 55

Basic design manufactured from profile-pressed sheet steel. The stator core is welded into the stator frame and contributes to its excellent mechanical properties. The end shields are made from cast iron. Drain holes and plugs are fitted as standard. This construction provides efficient, light weight motors. See catalogue BA/M2CA GB for details.

## Thread sizes

In motor sizes 63 - 250 the cable glands are not included in delivery. In motor sizes 280 - 400 the terminal box is equipped with cable glands or cable boxes. Exact information is available from the appropriate product catalogues.

## Cast iron motors totally enclosed fan cooled, IP 55

Heavy duty design, manufactured from extra corrosion resistant cast iron materials for use in all kinds of environments. The motor is mechanically strong and robust and designed for additional energy saving when using frequency converter drives. Drain holes and and plugs are fitted as standard in sizes 160-400. See catalogue BA/M3BP GB for details.

## Open drip proof motors, IP 23 S

The basic construction uses the same sheet steel as motor type M2CA. The open drip proof design gives advantages of high output and extremely low weight.

Frame size	Metric cable gland
<b>Aluminium motors</b>	
56-63	1 x M16
71-80	2 x M20
90-100	2 x M20
112-132	M25 + M20
160-180	2 x M40 + M16
200-250, $U_n \geq 380$ V	2 x M40 + M16
200-250, $U_n < 380$ V	2 x M63 + M16
<b>Steel motors, open drip proof motors</b>	
280	2 x M63 + M20
315 SA	2 x M63 + M20
315 SMA, MB	2 x M63 + M20
355, all variants	cable box acc. to catalogue
400, all variants	cable box acc. to catalogue

Frame size	Metric cable gland
<b>Cast Iron motors</b>	
71	2 x M16
80-90	2 x 25
100-112	2 x M32
132	2 x M32
160-180	2 x M40 + M16
200-250	2 x M63 + M16
280 SM	2 x M63 + M20
315 SM_, ML_	2 x M63 + M20
355, all variants	cable box acc. to catalogue
400, all variants	cable box acc. to catalogue

# Bearings

Motor sizes	Poles	Bearing D-end	Bearing N-end
<b>Aluminium motors</b>			
56	2-8	6201-2Z/C3	6201-2Z/C3
63	2-8	6202-2Z/C3	6201-2Z/C3
71	2-8	6202-2Z/C3	6202-2Z/C3
80	2-8	6204-2Z/C3	6203-2Z/C3
90	2-8	6305-2Z/C3	6204-2Z/C3
100	2-8	6306-2Z/C3	6205-2Z/C3
112	2-8	6206-2Z/C3	6205-2Z/C3
132	2-8	6208-2Z/C3	6206-2Z/C3
160	2-8	6309-2Z/C3	6209-2Z/C3
180	2-8	6310-2Z/C3	6209-2Z/C3
200	2-8	6312/C3	6210/C3
225	2-8	6313/C3	6212/C3
250	2-8	6315/C3	6213/C3
<b>Steel motors</b>			
280	2	6316/C4	6316/C4
280	4-8	6316/C3	6316/C3
315	2	6316/C4	6316/C4
315	4-8	6319/C4	6316/C3
355	2	6319M/C4	6319M/C4
355	4-8	6322/C3	6319/C3
400	2	6319M/C4	6319M/C4
400	4-12	6322/C3	6319/C3

Motor size	Poles	Bearing D-end	Bearing N-end
<b>Cast iron motors</b>			
71	2-6	6202 2RS C3	6202 2RS C3
80	2-6	6204 2RS C3	6204 2RS C3
90	2-6	6205 2RS C3	6205 2RS C3
100	2-6	6206 2RS C3	6206 2RS C3
112	2-6	6207 2RS C3	6207 2RS C3
132	2-6	6208 2RS C3	6208 2RS C3
160	2-12	6309/C3	6309/C3
180	2-12	6310/C3	6309/C3
200	2-12	6312/C3	6310/C3
225	2-12	6313/C3	6312/C3
250	2-12	6315/C3	6313/C3
280	2	6316/C4	6316/C4
280	4-12	6316/C3	6316/C3
315	2	6316/C4	6316/C4
315	4-8	6319/C3	6316/C3
355	2	6319M/C4	6319M/C4
355	4-12	6322/C3	6319/C3
400	2	6319M/C4	6319M/C4
400	4-12	6322/C3	6319/C3
<b>Open drip proof motors, IP 23S</b>			
250	2	6316/C4	6316/C4
250	4-8	6316/C3	6316/C3
280	2	6316/C4	6316/C4
280	4-8	6319/C3	6316/C3
315	2	6316/C4	6316/C4
315	4-8	6319/C3	6316/C3
355	2	6319M/P64	6319M/P64
355	4-8	6322/C3	6319/C3

## “Essential Service”

The motors fulfil the requirements for “Essential Service”. Different classification societies have different requirements. Lloyd’s Register of Shipping mentions the following examples of essential service equipment on board of ships:

Other classification societies may have other requirements:

Air compressors for heavy oil engines  
 Scavenge blowers  
 Air pumps  
 Ballast pumps  
 Bilge pumps  
 Circulating and cooling water pumps  
 Condenser circulating pumps  
 Extractions pumps

Feed water pumps  
 Fire pumps  
 Lubrication oil pumps  
 Oil fuel pumps and oil fuel burning units  
 Cargo refrigerating motors, including compressors, brine pumps, circulating pumps, fans etc.  
 Fans for force draught to boilers  
 Steering gear  
 Windlasses  
 Ventilating fans for engine room and boiler rooms  
 Oil separators

# Requirements for electric motors used in Essential and Non-Essential Services according to Classification Societies Requirements

ABB has through close co-operation with the Classification Societies gained 'Type Approval' from all those Societies who require it (please see the column 'Type approved motors' in the table below). For those Classification Societies who do not require 'Type Approval' there are no specified motors mentioned in the column 'Type approved motors'.

Classification Society's requirement and standard test procedure								ABB Type Approved motors and supplied documentation					
Classification Society	Required ambient temperature	Max. temper. rise accepted by Classif. Societies degree C. B/F	Duty 1)	Output limit kW	Witnessed test requirement	Test report accepted when based on motor with identical data	Complete test on motor no 1, routine test for remaining batch +147/153	Aluminium motors 4)5)	Cast iron motors 4)5)	Steel motors 4)5)	Open drip proof motors 4)5)	Flame-proof motors 4)5)	Classification societies acceptance of supplied documents 2)
<b>ABS</b> 6)	50	70 / 95	E N E	< 100 kW ≥ 100 kW	X	X	X						P None, I, 3 C1
<b>BV</b>	45	75 / 100	E N E	< 50 kW ≥ 50 kW	X	X	X	112 - 250 200 - 250	280-400	280-400	250-400		I, P None, I, 3 C1, C3
<b>CCS</b>	45	75 / 95	E N E	< 50 kW > 50 kW	X	X	X	112-250 200-250	280-400	280-400	250-400		C1, C3 None, I, 3 C1, C3
<b>CR</b>	45	75 / 95	E N	No limit	X	X	X	112-250	280-400	280-400	250-400	280-400	C1, C3 None, I, 3
<b>DNV</b>	45	70 / 95	E N E	< 100 kW ≥ 100 kW	X	X	X		280-355	280-355	280-355		I, P None, I, 3 C1, C3
<b>GL</b>	45	75 / 100	E N E/S/K	< 50 kW ≥ 50 kW	X	X	X	112-250 112-250	280-400	280-400	250-400		I, P None, I, 3 C1, C3
<b>KR</b>	50	70 / 90	E N E	< 7.5 kW ≥ 7.5 kW	X	X	X	112-250 112-250	280-400	280-400	250-400	280 - 400	C1, C3 None, I, 3 C1, C3
<b>LR</b> 7)	45	70 / 95	E N E/F	< 100 kW ≥ 100 kW	X	X	X						P None, I, 3 C1
<b>NK</b> 6) 9)	45 8)	75 / 100	E N E	< 50 kW ≥ 50 kW	X	X	X	112-250 200-250	280-400	280-400	250-400		P None, I, 3 C1, C3
<b>RINA</b>	45	75 / 95	E N E	< 50 kW ≥ 50 kW	X	X	X	90-250 200-250	280-400	280-400	250-400	280-400	I, P None, I, 3 C1, C3
<b>RS</b>	45	75 / 95	E N E	< 75 kW ≥ 75 kW	X	X	X	112-250 225-250	280-400	280-355	250-400		C3 None, I, 3 C1, C3

## 1) Duty

- E = Essential Service
- F = Fans and Refrigerated Cargo Holds
- K = Refrigerating Plants with Class Certificate
- N = Non Essential Service (No document requirement)
- S = Steering Gear and Anchor Winch (windlass)

## 2) Documentation

- I = ABB Motors Test Confirmation/ Routine Test Report (included in marine design)
- P = ABB Motors Test Report (Type test as basis) (included in marine design)
- C1 = Classification Society's Certificate based on witness test (Classification Society's Certificate fee will be charged)
- C2 = ABB Motors Test Report stamped by Classification Society (Classification Society's Certificate fee will be charged)
- C3 = Classification Society's Certificate issued with ABB Motors Test Report as basis (Classification Society's Certificate fee will be charged)

## 3) Non-Essential (Important) Service. Claim for documentation

Serial No. and Documentation not required by Classification Societies. (Upon request ABB can supply Test Confirmation/Type Test Report).

## 4) Type Approval / Motors are type approved.

## 5) Design Approval / ABS only design approval apply.

## Classified Shaft material

- 6) => 375 kW, classified shaft required
- 7) => 100 kW, classified shaft required

## 8) Required ambient temperature with EEx 50°C

=> max. temperature rise for B-class = 70 K and F-class 95 K.

## 9) NK Essential Service and Japanese flag = No kW limit.



# Ordering information

## Sample order

When placing an order, the motor type, size and product code must be specified. The product code of the motor is composed

in accordance with the following example.

### Motor size

A            B            C            D, E, F, G

**M3AA 112 M 3GAA 111 001 - ADA, 027 etc.**

**M3BP 180 L 3GBP 182 102 - ADA**

1	2	3	4	5	6	7	8	9	10	11	12	13	14
---	---	---	---	---	---	---	---	---	----	----	----	----	----

- A Motor type
- B Motor size
- C Product code
- D Mounting arrangement code
- E Voltage and frequency code
- F Generation code
- G Variant codes

### Explanation of the product code:

#### Positions 1 to 4

**3GVA/3GAA** = Totally enclosed motor with aluminium frame  
**3GCA** = Totally enclosed motor with steel frame  
**3GBA/3GBP** = Totally enclosed motor with cast iron frame  
**3GFA** = Open drip proof motor with steel frame

#### Positions 5 and 6

##### IEC-frame

<b>05</b> = 56	<b>11</b> = 112	<b>25</b> = 250
<b>06</b> = 63	<b>13</b> = 132	<b>28</b> = 280
<b>07</b> = 71	<b>16</b> = 160	<b>31</b> = 315
<b>08</b> = 80	<b>18</b> = 180	<b>35</b> = 355
<b>09</b> = 90	<b>20</b> = 200	<b>40</b> = 400
<b>10</b> = 100	<b>22</b> = 225	

#### Position 7

##### Speed (Pole pairs)

<b>1</b> = 2 poles	<b>6</b> = 12 poles
<b>2</b> = 4 poles	<b>7</b> => 12 poles
<b>3</b> = 6 poles	<b>8</b> = Two-speed motors
<b>4</b> = 8 poles	<b>9</b> = Multi-speed motors
<b>5</b> = 10 poles	

#### Position 8 to 10

Serial number

#### Position 11

- (dash)

#### Position 12

##### Mounting arrangement

**A** = Foot-mounted, top-mounted terminal box  
**R** = Foot-mounted, terminal box RHS seen from D-end  
**L** = Foot-mounted, terminal box LHS seen from D-end  
**B** = Flange-mounted, large flange  
**C** = Flange-mounted, small flange (sizes 71 to 112)  
**H** = Foot- and flange-mounted, terminal box top-mounted  
**J** = Foot- and flange-mounted, small flange with tapped holes  
**N** = Flange-mounted, modular cast iron flange with clearance holes  
**P** = Foot- and flange-mounted, modular cast iron flange with clearance holes  
**S** = Foot- and flange-mounted, terminal box RHS seen from D-end  
**T** = Foot- and flange-mounted, terminal box LHS seen from D-end  
**V** = Flange-mounted, special flange  
**F** = Foot- and flange-mounted. Special flange

#### Position 13

##### Voltage and frequency code

See table below

#### Position 14

##### Generation code

A, B, C...

The product code must be, if needed, followed by variant codes.

### Code letters for supplementing the product code - single speed motors

Code letter for voltage and frequency					
A	B	D	E	F	H
380 VY 50 Hz	<del>380</del> VΔ 50 Hz	380-420 VΔ 50 Hz 660-690 VY 50 Hz 440-480 VΔ 60 Hz	500 VΔ 50 Hz 575 VΔ 60 Hz	500 VY 50 Hz 575 VY 60 Hz	415 VΔ 50 Hz
S	T	U	X		
220-240 VΔ 50 Hz 380-420 VY 50 Hz 440-480 VY 60 Hz	660 VΔ 50 Hz	690 VΔ 50 Hz	Other rated voltage, connection or frequency, max. 690 V		

### Code letters for supplementing the product code - two speed motors

Code letter for voltage and frequency					
A	B	D	E	H	S
220 V 50 Hz	380 V 50 Hz	380-400 V 50 Hz 440-480 V 60 Hz	500 V 50 Hz 575 V 60 Hz	400-415 V 50 Hz 460-480 V 60 Hz	220-230 V 50 Hz

# Technical data

## Marine motors with aluminium and steel frame

IP 55 - IC 411 - Temperature rise 90 K

Output kW	Motor type	Product code	Speed r/min	Efficiency %	Power factor cos φ	Current		Torque				
						I <sub>N</sub> A	I <sub>s</sub> A	T <sub>N</sub> Nm	T <sub>s</sub> Nm	T <sub>max</sub> Nm		
<b>3000 r/min = 2 poles</b>						<b>380 V 50 Hz</b>						
<b>Aluminium frame</b>												
0.09	M2VA	56 A	3GVA	051 001-...A	2805	58.6	0.72	0.32	3.8	0.31	2.7	2.5
0.12	M2VA	56 B	3GVA	051 002-...A	2825	69.2	0.68	0.4	4.1	0.41	2.8	2.4
0.18	M2VA	63 A	3GVA	061 001-...A	2815	74.6	0.69	0.53	3.9	0.62	2.9	2.5
0.25	M2VA	63 B	3GVA	061 002-...A	2800	78.5	0.75	0.64	4.4	0.87	3.3	3.0
0.37	HO M2VA	63 BB	3GVA	061 003-...A	2790	71.6	0.84	0.92	3.3	1.29	2.0	1.9
0.37	M2VA	71 A	3GVA	071 001-...A	2830	77.3	0.80	1	5.4	1.25	3.4	3.5
0.55	M2VA	71 B	3GVA	071 002-...A	2820	80.2	0.81	1.35	5.5	1.86	3.3	3.4
0.68	HO M2VA	71 BB	3GVA	071 003-...A	2790	77.4	0.85	1.6	5.0	2.33	2.9	3.0
0.75	HO M2VA	71 BC	3GVA	071 004-...A	2790	76.0	0.87	1.75	4.9	2.57	2.8	2.9
0.75	M2VA	80 A	3GVA	081 001-...A	2850	82.2	0.80	1.7	6.1	2.51	2.7	3.4
1.1	M2VA	80 B	3GVA	081 002-...A	2830	81.1	0.84	2.47	5.9	3.72	2.2	3.4
1.5	HO M2VA	80 C	3GVA	081 003-...A	2760	80.9	0.89	3.1	5.3	5.19	2.6	2.9
1.5	M2AAM	90 S	3GAA	091 001-...A	2850	79.7	0.88	3.4	5.9	4.7	2.1	2.7
2.2	M2AAM	90 L	3GAA	091 002-...A	2850	81.8	0.89	4.7	6.5	7	2.2	2.7
3	M2AAM	100 L	3GAA	101 001-...A	2880	86.0	0.90	6.3	7.2	10.1	2.2	3.2
4	M3AA	112 M	3GAA	111 001-...A	2840	84.5	0.91	7.9	6.3	13.4	2.2	2.7
4.9	HO M3AA	112 MB	3GAA	111 002-...C	2855	87.0	0.94	9.2	7.6	16.4	2.6	2.9
5.5	M3AA	132 SA	3GAA	131 001-...A	2830	85.5	0.92	10.9	7.0	18.6	2.9	3.0
7.5	M3AA	132 SB	3GAA	131 002-...A	2830	86.5	0.92	14.7	7.1	25.3	2.9	3.2
9.5	HO M3AA	132 SC	3GAA	131 003-...C	2855	87.5	0.94	17.6	8.8	31.8	3.6	3.5
11	M3AA	160 MA	3GAA	161 101-...C	2885	88.7	0.90	24	5.2	41	1.7	2.2
15	M3AA	160 M	3GAA	161 102-...C	2905	91.1	0.90	27.5	5.5	51	1.9	2.1
18.5	M3AA	160 L	3GAA	161 103-...C	2910	92.1	0.91	33.5	6.3	61	2.3	2.5
21	HO M3AA	160 LB	3GAA	161 104-...C	2915	92.0	0.92	38	6.9	69	2.4	2.6
22	M3AA	180 M	3GAA	181 101-...C	2930	91.6	0.90	40.5	5.7	75	2.1	2.4
30	HO M3AA	180 LB	3GAA	181 102-...C	2940	93.1	0.90	55	7.5	101	2.8	3.0
30	M3AA	200 MLA	3GAA	201 001-...C	2955	93.1	0.89	55	6.6	97	3.2	2.5
37	M3AA	200 MLB	3GAA	201 002-...C	2950	93.4	0.89	68	6.5	120	2.3	2.9
45	HO M3AA	200 MLC	3GAA	201 003-...C	2945	93.5	0.89	82	6.6	147	2.3	2.9
49	HO M3AA	200 MLD	3GAA	201 004-...C	2940	94.0	0.90	89	8.0	159	3.1	3.1
45	M3AA	225 SMB	3GAA	221 001-...C	2955	93.7	0.89	82	6.4	151	2.3	2.5
55	HO M3AA	225 SMC	3GAA	221 002-...C	2950	94.2	0.89	100	6.1	184	2.2	2.6
73	HO M3AA	225 SMD	3GAA	221 003-...C	2960	95.0	0.88	134	7.5	236	2.8	3.1
55	M3AA	250 SMA	3GAA	251 001-...C	2960	94.3	0.89	100	6.6	184	1.8	2.7
75	HO M3AA	250 SMB	3GAA	251 002-...C	2965	95.0	0.90	134	6.6	241	1.9	2.7
86	HO M3AA	250 SMC	3GAA	251 003-...C	2965	95.1	0.91	152	8.0	277	2.5	3.2
<b>Steel frame</b>												
75	M2CA	280 SA	3GCA	281 110-...A	2974	94.8	0.89	137	6.8	241	2.1	2.9
90	M2CA	280 SMA	3GCA	281 210-...A	2970	95.1	0.90	159	6.7	289	2.1	2.8
110	HO M2CA	280 MB	3GCA	281 320-...A	2974	95.7	0.91	193	7.1	353	2.3	2.7
110	HO M2CA	280 MC	3GCA	281 330-...A	2972	95.9	0.91	233	7.0	424	2.3	2.7
160	HO M2CA	280 MD	3GCA	281 340-...A	2971	95.9	0.91	280	7.1	514	2.5	2.8
110	M2CA	315 SA	3GCA	311 110-...A	2980	95.1	0.87	202	6.9	353	1.8	2.7
132	M2CA	315 SMA	3GCA	311 210-...A	2980	95.4	0.89	238	6.7	423	2.0	2.7
160	M2CA	315 MB	3GCA	311 320-...A	2979	96.1	0.90	282	6.8	513	2.1	2.7
200	M2CA	315 LA	3GCA	311 510-...A	2977	96.3	0.90	350	7.0	642	2.4	2.7
250	HO M2CA	315 LB	3GCA	311 520-...A	2977	96.4	0.90	442	7.3	802	2.5	2.6
315	HO M2CA	315 LC	3GCA	311 530-...A	2979	96.8	0.90	550	8.1	1010	3.0	2.8
200	M2CA	355 SA	3GCA	351 110-...A	2975	95.4	0.92	350	6.0	642	1.1	2.5
250	M2CA	355 MA	3GCA	351 310-...A	2978	96.0	0.92	430	6.0	801	1.2	2.8
280	M2CA	355 MB	3GCA	351 320-...A	2975	96.0	0.92	495	5.1	898	1.0	2.5
315	M2CA	355 LA	3GCA	351 510-...A	2976	96.5	0.93	540	6.7	1010	1.2	3.0
355	M2CA	355 LB	3GCA	351 520-...A	2972	96.0	0.92	605	6.2	1140	0.9	2.8
400	M2CA	400 MLA	3GCA	401 410-...A	2980	96.5	0.92	680	6.7	1281	0.7	2.7
460	M2CA	400 LKA	3GCA	401 510-...A	2983	96.6	0.92	780	6.9	1472	0.7	3.3
500	M2CA	400 LKB	3GCA	401 520-...A	2983	96.7	0.92	860	7.1	1600	0.7	3.3

HO = High output design (Cenelec +1)

<sup>1)</sup> On request.

The two bullets indicate a 2-letter product code supplement for choice of mounting arrangement, and voltage and frequency; see ordering information.

Output kW	Motor type	Speed r/min	Efficiency %	Power factor cos φ	Current		Torque			Moment of inertia J = 1/4 GD <sup>2</sup> kgm <sup>2</sup>	Weight kg
					I <sub>N</sub> A	I <sub>s</sub> / I <sub>N</sub>	T <sub>N</sub> Nm	T <sub>s</sub> / T <sub>N</sub>	T <sub>max</sub> / T <sub>N</sub>		
<b>3600 r/min = 2 poles 440 V 60 Hz</b>											
<b>Aluminium frame</b>											
0.10	M2VA 56 A	3385	58.8	0.70	0.32	3.9	0.28	2.7	2.5	0.000017	3.2
0.14	M2VA 56 B	3405	68.2	0.66	0.41	4.1	0.39	2.8	2.4	0.000018	3.4
0.22	M2VA 63 A	3385	73.8	0.70	0.56	4.2	0.62	2.9	2.5	0.000032	3.9
0.32	M2VA 63 B	3375	80.6	0.78	0.67	4.5	0.9	2.9	2.6	0.000037	4.4
0.45	HO M2VA 63 BB	3360	76.4	0.86	0.9	3.5	1.28	2.0	1.9	0.000039	4.9
0.50	M2VA 71 A	3405	81.3	0.77	1.05	5.5	1.4	2.9	3.0	0.000112	5.5
0.75	M2VA 71 B	3395	82.1	0.80	1.5	5.7	2.11	2.7	2.8	0.000128	6.5
0.82	HO M2VA 71 BB	3360	79.6	0.82	1.65	5.2	2.33	2.7	2.8	0.000128	6.5
0.90	HO M2VA 71 BC	3360	77.7	0.80	1.9	5.1	2.56	2.6	2.7	0.000128	6.5
1.0	M2VA 80 A	3445	78.2	0.84	2.0	6.2	2.77	2.2	2.9	0.000722	9
1.3	M2VA 80 B	3420	83.3	0.82	2.5	6.1	3.63	2.0	3.2	0.000763	11
1.6	HO M2VA 80 C	3360	81.4	0.89	2.9	5.5	4.55	2.6	2.9	0.001093	11.5
1.75	M2AAM 90 S	3420	79.7	0.88	3.4	5.9	4.6	2.1	2.7	0.0019	13
2.5	M2AAM 90 L	3420	81.8	0.89	4.7	6.5	6.6	2.2	2.7	0.0024	16
3.7	M2AAM 100 L	3455	86.0	0.90	6.3	7.2	9.8	2.2	3.2	0.0041	21
4.6	M3AA 112 M	3440	86.0	0.93	7.6	6.6	12.8	2.2	2.7	0.01	25
5.7	HO M3AA 112 MB	3445	88.0	0.93	9.1	7.7	15.8	2.4	2.8	0.012	33
6.4	M3AA 132 SA	3430	86.5	0.92	10.8	7.0	17.8	2.9	3.0	0.014	37
8.6	M3AA 132 SB	3430	87.5	0.92	14.6	7.1	23.9	2.9	3.2	0.016	42
11	HO M3AA 132 SC	3455	89.0	0.93	17.5	9.1	30.4	3.8	3.4	0.022	56
14.5	M3AA 160 MA	3485	88.7	0.90	24	5.2	40	1.5	2.1	0.039	73
17.5	M3AA 160 M	3505	91.1	0.91	28.5	5.5	48	1.7	2.1	0.047	84
21	M3AA 160 L	3510	92.1	0.92	33.5	6.3	57	2.1	2.3	0.053	94
24	HO M3AA 160 LB	3515	92.0	0.92	38	6.9	65	2.2	2.6	0.058	100
26	M3AA 180 M	3520	91.6	0.90	42.5	5.7	72	2.1	2.4	0.077	119
35	HO M3AA 180 LB	3540	93.1	0.91	56	7.5	96	2.5	3.0	0.092	137
35	M3AA 200 MLA	3555	93.1	0.89	55	6.6	94	2.7	2.4	0.15	175
43	M3AA 200 MLB	3550	93.4	0.89	68	6.5	116	2.0	2.8	0.18	200
52	HO M3AA 200 MLC	3545	93.5	0.89	82	6.6	140	2.1	2.9	0.19	205
57	HO M3AA 200 MLD	3540	94.0	0.90	89	8.0	154	2.9	3.0	0.2	215
54	M3AA 225 SMB	3555	93.7	0.89	86	6.4	145	2.1	2.4	0.26	235
65	HO M3AA 225 SMC	3550	94.2	0.89	103	6.1	174	2.0	2.6	0.29	260
85	HO M3AA 225 SMD	3560	95.0	0.88	134	7.5	228	2.6	2.9	0.3	275
65	M3AA 250 SMA	3555	94.3	0.91	101	6.6	175	1.6	2.7	0.49	285
86	HO M3AA 250 SMB	3565	95.0	0.90	134	6.6	231	1.7	2.6	0.57	330
99	HO M3AA 250 SMC	3565	95.1	0.91	152	8.0	265	2.3	3.1	0.59	345
<b>Steel frame</b>											
90	M2CA 280 SA	3570	94.2	0.89	139	6.7	241	1.8	2.8	0.8	480
105	M2CA 280 SMA	3568	94.6	0.90	163	6.6	281	1.9	2.8	0.9	545
125	HO M2CA 280 MB	3572	95.2	0.91	190	7.3	334	2.1	2.7	1.15	580
150	HO M2CA 280 MC	3572	95.7	0.91	230	7.1	401	2.2	2.7	1.4	755
184	HO M2CA 280 MD	3570	95.8	0.91	280	7.1	492	2.6	3.2	1.55	810
125	M2CA 315 SA	3580	94.5	0.88	198	7.3	333	1.6	2.6	1.2	695
155	M2CA 315 SMA	3578	95.0	0.89	238	6.7	400	1.8	2.6	1.4	770
185	M2CA 315 MB	3578	95.5	0.90	282	7.1	494	1.9	2.6	1.7	840
230	M2CA 315 LA	3576	95.9	0.91	350	7.2	614	2.1	2.6	2.1	975
288	HO M2CA 315 LB	3576	96.1	0.90	438	7.4	769	2.3	2.6	2.65	1230
362	HO M2CA 315 LC	3578	96.5	0.90	550	8.3	966	2.8	2.8	3.3	1410
225	M2CA 355 SA	3574	94.7	0.92	340	6.0	601	1.0	2.5	3.2	1220
285	M2CA 355 MA	3577	95.8	0.92	425	6.2	760	1.2	2.8	3.8	1320
315	M2CA 355 MB	3575	95.7	0.91	490	5.2	841	1.0	2.6	3.8	1320
360	M2CA 355 LA	3573	96.0	0.92	535	6.8	962	1.1	3.0	4.8	1530
400	M2CA 355 LB	3574	96.3	0.92	595	6.8	1068	1.0	2.8	4.8	1550
1)	M2CA 400 MLA									7.2	2300
1)	M2CA 400 LKA									8.5	2700
1)	M2CA 400 LKB									8.5	2700

# Technical data

## Marine motors with aluminium and steel frame

IP 55 - IC 411 - Temperature rise 90 K

Output kW	Motor type	Product code	Speed r/min	Effi- ciency %	Power factor cos φ	Current		Torque					
						I <sub>N</sub> A	I <sub>s</sub> A	T <sub>N</sub> Nm	T <sub>s</sub> Nm	T <sub>max</sub> Nm			
<b>1500 r/min = 4 poles</b>						<b>380 V 50 Hz</b>							
<b>Aluminium frame</b>													
0.06	M2VA	56 A	3GVA	052 001-***A	1335	50.5	0.70	0.28	2.4	0.43	2.0	2.0	
0.09	M2VA	56 B	3GVA	052 002-***A	1360	57.1	0.66	0.38	2.7	0.63	2.6	2.6	
0.12	M2VA	63 A	3GVA	062 001-***A	1390	63.1	0.63	0.43	3.0	0.82	2.5	2.5	
0.18	M2VA	63 B	3GVA	062 002-***A	1370	66.9	0.67	0.62	3.0	1.25	2.2	2.2	
0.25	HO	M2VA	63 BB	3GVA	062 003-***A	1360	70.9	0.71	0.76	3.1	1.75	2.2	1.8
0.25		M2VA	71 A	3GVA	072 001-***A	1400	69.9	0.74	0.75	4.0	1.71	2.5	2.7
0.37		M2VA	71 B	3GVA	072 002-***A	1410	74.6	0.73	1	4.2	2.51	2.4	2.6
0.45	HO	M2VA	71 BB	3GVA	072 003-***A	1380	75.1	0.79	1.1	3.9	3.11	1.9	2.1
0.55	HO	M2VA	71 C	3GVA	072 004-***A	1400	77.0	0.77	1.4	4.6	3.74	2.4	2.6
0.55		M2VA	80 A	3GVA	082 001-***A	1370	75.5	0.76	1.48	4.5	3.84	2.4	2.8
0.75		M2VA	80 B	3GVA	082 002-***A	1390	78.7	0.72	2.02	4.8	5.16	3.1	3.6
0.95	HO	M2VA	80 C	3GVA	082 003-***A	1410	79.1	0.68	2.7	4.6	6.45	2.9	3.2
1.1		M2AAM	90 S	3GAA	092 001-***A	1410	76.3	0.83	2.66	4.6	7	2.0	2.4
1.5		M2AAM	90 L	3GAA	092 002-***A	1420	79.9	0.82	3.5	5.2	9.5	2.1	2.6
2.2		M2AAM	100 LA	3GAA	102 001-***A	1430	83.0	0.83	4.83	5.8	14	2.1	2.6
3		M2AAM	100 LB	3GAA	102 002-***A	1430	85.0	0.85	6.58	5.7	19.1	2.2	2.6
4		M3AA	112 M	3GAA	112 001-***A	1425	85.0	0.84	8.7	6.3	27	2.3	2.8
4.9	HO	M3AA	112 MB	3GAA	112 002-***C	1430	85.0	0.85	10.3	7.4	33	2.8	3.2
5.5		M3AA	132 S	3GAA	132 001-***A	1445	85.5	0.85	11.5	7.2	36	2.2	2.7
7.5		M3AA	132 M	3GAA	132 002-***A	1445	88.0	0.85	15.5	7.5	50	2.4	2.9
9.5	HO	M3AA	132 MB	3GAA	132 003-***C	1455	88.5	0.86	19	8.0	62	2.3	2.8
11		M3AA	160 M	3GAA	162 101-***A	1450	88.4	0.83	22.5	5.6	76	2.1	2.3
15		M3AA	160 L	3GAA	162 102-***A	1445	91.0	0.84	30	6.5	102	2.9	2.8
17.5	HO	M3AA	160 LB	3GAA	162 103-***C	1450	90.7	0.84	35	7.5	115	3.1	3.0
18.5		M3AA	180 M	3GAA	182 101-***C	1465	91.6	0.85	36	6.0	124	2.8	2.4
22		M3AA	180 L	3GAA	182 102-***A	1465	91.4	0.84	43	6.2	147	2.6	2.2
28	HO	M3AA	180 LB	3GAA	182 103-***C	1465	92.9	0.85	55	7.9	183	3.5	2.7
30		M3AA	200 MLA	3GAA	202 004-***C	1470	92.6	0.83	59	6.0	195	2.3	2.5
37	HO	M3AA	200 MLB	3GAA	202 002-***C	1475	93.3	0.85	71	7.1	236	3.2	2.9
44	HO	M3AA	200 MLC	3GAA	202 003-***C	1470	94.1	0.85	85	8.1	285	4.0	3.0
37		M3AA	225 SMA	3GAA	222 001-***C	1475	93.4	0.84	72	5.7	246	2.2	2.2
45		M3AA	225 SMB	3GAA	222 002-***C	1475	94.0	0.85	86	5.7	310	2.4	2.3
55	HO	M3AA	225 SMC	3GAA	222 003-***C	1475	94.5	0.84	105	6.4	369	2.8	2.5
67	HO	M3AA	225 SMD	3GAA	222 004-***C	1475	94.5	0.86	126	8.2	434	3.9	3.2
55		M3AA	250 SMA	3GAA	252 001-***C	1475	94.3	0.86	103	6.6	369	2.1	2.5
75	HO	M3AA	250 SMB	3GAA	252 002-***C	1475	94.5	0.87	139	6.1	499	2.2	2.7
88	HO	M3AA	250 SMC	3GAA	252 003-***C	1475	95.0	0.89	160	7.1	571	2.5	2.7
<b>Steel frame</b>													
75		M2CA	280 SA	3GCA	282 110-***A	1481	94.6	0.86	142	6.3	484	2.2	2.4
90		M2CA	280 SMA	3GCA	282 210-***A	1482	95.1	0.86	169	6.5	580	2.4	2.6
110	HO	M2CA	280 MB	3GCA	282 320-***A	1481	95.2	0.87	204	6.6	710	2.3	2.5
132	HO	M2CA	280 MC	3GCA	282 330-***A	1481	95.4	0.87	245	6.4	851	2.5	2.6
160	HO	M2CA	280 MD	3GCA	282 340-***A	1481	95.5	0.87	295	6.4	1032	2.5	2.7
110		M2CA	315 SA	3GCA	312 110-***A	1486	95.3	0.86	204	6.4	707	1.9	2.5
132		M2CA	315 SMA	3GCA	312 210-***A	1485	95.5	0.86	245	6.1	849	2.0	2.4
160		M2CA	315 MB	3GCA	312 320-***A	1485	95.9	0.87	294	6.6	1029	2.1	2.6
200		M2CA	315 LA	3GCA	312 510-***A	1484	96.1	0.87	365	6.6	1286	2.2	2.6
250	HO	M2CA	315 LB	3GCA	312 520-***A	1485	95.9	0.86	463	6.7	1608	2.2	2.6
315	HO	M2CA	315 LC	3GCA	312 530-***A	1485	96.1	0.86	582	7.1	2026	2.3	2.9
200		M2CA	355 SA	3GCA	352 110-***A	1485	95.7	0.87	360	6.3	1286	1.8	2.5
250		M2CA	355 MA	3GCA	352 310-***A	1486	96.4	0.87	455	6.4	1606	2.0	2.5
315		M2CA	355 LA	3GCA	352 510-***A	1486	96.4	0.87	570	6.7	2024	2.2	2.6
355		M2CA	355 LB	3GCA	352 520-***A	1487	96.4	0.89	630	6.5	2279	1.3	2.7
400		M2CA	355 LKD	3GCA	352 540-***A	1487	96.6	0.89	710	6.8	2568	1.3	2.7
450		M2CA	400 MLA	3GCA	402 410-***A	1487	96.6	0.90	770	6.2	2890	1.1	2.5
500		M2CA	400 MLB	3GCA	402 420-***A	1488	96.7	0.90	870	6.6	3209	1.1	2.6
560		M2CA	400 LKA	3GCA	402 510-***A	1487	96.8	0.91	965	6.0	3596	1.0	2.4
600		M2CA	400 LKB	3GCA	402 520-***A	1488	96.8	0.88	1070	6.4	3850	1.1	2.6

HO = High output design (Cenelec +1)

The two bullets indicate a 2-letter product code supplement for choice of mounting arrangement, and voltage and frequency; see ordering information.

Output kW	Motor type	Speed r/min	Efficiency %	Power factor cos φ	Current		Torque			Moment of inertia J = 1/4 GD <sup>2</sup> kgm <sup>2</sup>	Weight kg
					I <sub>N</sub> A	I <sub>s</sub> A	T <sub>N</sub> Nm	T <sub>s</sub> Nm	T <sub>max</sub> Nm		
<b>1800 r/min = 4 poles 440 V 60 Hz</b>											
<b>Aluminium frame</b>											
0.075	M2VA 56 A	1605	50.0	0.68	0.29	2.5	0.44	1.9	1.9	0.000021	3.2
0.10	M2VA 56 B	1645	52.9	0.64	0.39	2.8	0.58	2.3	2.3	0.000023	3.4
0.14	M2VA 63 A	1680	64.5	0.62	0.46	3.1	0.79	2.1	2.1	0.000038	4
0.26	M2VA 63 B	1655	68.6	0.78	0.64	3.1	1.5	1.8	1.9	0.000044	4.5
0.30	HO M2VA 63 BB	1645	72.2	0.70	0.78	3.2	1.74	2.1	1.7	0.000051	5
0.37	M2VA 71 A	1695	71.5	0.85	0.78	4.3	2.08	1.8	2.0	0.00014	5.5
0.50	M2VA 71 B	1705	76.2	0.75	1.05	4.4	2.8	2.0	2.2	0.00015	6.5
0.55	HO M2VA 71 BB	1665	78.5	0.80	1.15	4.1	3.15	1.8	2.0	0.00015	6.5
0.65	HO M2VA 71 C	1695	78.5	0.75	1.45	4.8	3.66	2.3	2.5	0.00017	7
0.70	M2VA 80 A	1665	76.6	0.75	1.6	4.6	4.02	2.1	2.4	0.001257	9
0.90	M2VA 80 B	1680	76.9	0.70	2.2	4.7	5.12	2.9	2.3	0.001565	10.5
1.2	HO M2VA 80 C	1705	77.6	0.70	2.9	4.3	6.73	2.4	2.8	0.001948	11
1.3	M2AAM 90 S	1700	76.3	0.83	2.66	4.6	6.8	2.0	2.4	0.0032	13
1.75	M2AAM 90 L	1710	79.9	0.82	3.5	5.2	9.2	2.1	2.6	0.0043	16
2.5	M2AAM 100 LA	1720	83.0	0.83	4.83	5.8	13.2	2.1	2.6	0.0069	21
3.5	M2AAM 100 LB	1720	85.0	0.85	6.58	5.7	18.5	2.2	2.6	0.0082	24
4.6	M3AA 112 M	1725	86.5	0.84	8.5	6.5	26	2.3	2.7	0.015	27
5.7	HO M3AA 112 MB	1730	86.5	0.85	10.2	7.5	32	2.6	3.1	0.018	34
6.4	M3AA 132 S	1745	86.5	0.86	11.4	7.3	35	2.2	2.6	0.031	40
8.6	M3AA 132 M	1745	89.0	0.85	15.4	7.5	47	2.4	2.8	0.038	48
11	HO M3AA 132 MB	1755	89.5	0.85	19.1	8.0	60	2.2	2.7	0.048	59
13	M3AA 160 M	1740	88.4	0.85	23.5	5.6	71	1.9	2.3	0.067	75
18	M3AA 160 L	1750	91.0	0.85	30.5	6.5	98	2.6	2.7	0.091	94
20	HO M3AA 160 LB	1750	90.7	0.84	35	7.5	109	2.8	3.0	0.102	103
22	M3AA 180 M	1765	91.6	0.85	37.5	6.0	119	2.5	2.3	0.161	124
26	M3AA 180 L	1760	91.4	0.85	44	6.2	144	2.3	2.1	0.191	141
32	HO M3AA 180 LB	1765	91.8	0.85	55	7.9	176	3.1	2.6	0.225	161
35	M3AA 200 MLA	1770	92.6	0.83	59	6.0	189	2.0	2.4	0.29	180
42	HO M3AA 200 MLB	1775	93.3	0.85	71	7.1	226	2.9	2.8	0.34	205
51	HO M3AA 200 MLC	1770	94.1	0.85	85	8.1	275	3.9	2.9	0.38	270
44	M3AA 225 SMA	1775	93.4	0.84	74	5.7	237	2.0	2.2	0.37	215
55	M3AA 225 SMB	1775	94.0	0.85	92	6.7	296	2.2	2.3	0.42	230
65	HO M3AA 225 SMC	1775	94.5	0.84	109	6.4	350	2.5	2.5	0.49	265
78	HO M3AA 225 SMD	1775	94.5	0.86	126	8.2	420	3.8	3.1	0.56	290
65	M3AA 250 SMA	1775	94.3	0.86	107	6.6	350	1.9	2.5	0.72	275
88	HO M3AA 250 SMB	1775	94.5	0.87	142	6.1	474	2.0	2.7	0.88	335
99	HO M3AA 250 SMC	1775	95.0	0.89	155	7.1	550	2.4	2.6	0.95	360
<b>Steel frame</b>											
88	M2CA 280 SA	1780	95.1	0.86	144	6.2	472	2.0	2.4	1.15	445
105	M2CA 280 SMA	1780	95.3	0.87	167	6.7	563	2.3	2.6	1.4	490
125	HO M2CA 280 MB	1780	95.2	0.87	200	7.0	671	2.2	2.6	1.7	550
150	HO M2CA 280 MC	1780	95.6	0.87	238	6.9	805	2.5	2.7	2.3	775
185	HO M2CA 280 MD	1780	95.4	0.87	294	6.6	992	2.4	2.8	2.5	820
125	M2CA 315 SA	1785	95.1	0.87	200	6.5	668	1.8	2.5	2	675
150	M2CA 315 SMA	1784	95.3	0.87	238	6.4	803	1.9	2.4	2.3	730
185	M2CA 315 MB	1785	95.8	0.87	290	6.8	990	2.0	2.6	2.9	850
230	M2CA 315 LA	1784	96.0	0.87	362	6.8	1230	2.2	2.6	3.5	970
288	HO M2CA 315 LB	1784	95.9	0.86	460	7.0	1542	2.2	2.6	4.4	1200
362	HO M2CA 315 LC	1785	96.2	0.86	574	7.5	1937	2.3	2.9	5.5	1380
230	M2CA 355 SA	1785	95.5	0.87	360	6.3	1230	1.7	2.4	5.5	1220
285	M2CA 355 MA	1785	96.1	0.87	450	6.5	1524	1.9	2.7	6.5	1350
345	M2CA 355 LA	1787	96.3	0.87	535	7.2	1843	1.9	2.7	7.8	1550
400	M2CA 355 LB	1788	96.4	0.89	615	6.7	2136	1.2	2.7	7.8	1550
450	M2CA 355 LKD	1787	96.5	0.89	690	6.9	2404	1.3	2.8	10	1900
500	M2CA 400 MLA	1787	96.5	0.90	750	6.3	2672	1.1	2.6	13	2400
550	M2CA 400 MLB	1788	96.6	0.90	825	6.7	2937	1.1	2.6	13	2400
600	M2CA 400 LKA	1788	96.7	0.90	890	6.2	3204	1.1	2.5	14	2700
670	M2CA 400 LKB	1788	96.7	0.88	1030	6.4	3578	1.0	2.6	15	2800

# Technical data

## Marine motors with aluminium and steel frame

IP 55 - IC 411 - Temperature rise 90 K

Output kW	Motor type	Product code	Speed r/min	Efficiency %	Power factor cos φ	Current		Torque					
						$I_N$ A	$I_s$ $I_N$	$T_N$ Nm	$T_s$ $T_N$	$T_{max}$ $T_N$			
<b>1000 r/min = 6 poles</b>						<b>380 V 50 Hz</b>							
<b>Aluminium frame</b>													
0.09	M2VA	63 A	3GVA	063 001-***A	905	49.6	0.59	0.46	2.0	0.95	1.8	1.8	
0.12	M2VA	63 B	3GVA	063 002-***A	905	59.1	0.61	0.54	2.0	1.27	1.8	1.8	
0.15	HO	M2VA	63 BB	3GVA	063 003-***A	895	55.9	0.59	0.75	2.1	1.61	1.9	2.0
0.18	M2VA	71 A	3GVA	073 001-***A	910	60.3	0.73	0.62	2.7	1.88	1.9	2.0	
0.25	M2VA	71 B	3GVA	073 002-***A	910	65.4	0.68	0.85	3.0	2.61	2.3	2.5	
0.32	HO	M2VA	71 C	3GVA	073 003-***A	910	65.6	0.67	1.1	3.1	3.33	2.4	2.6
0.37	M2VA	80 A	3GVA	083 001-***A	900	72.7	0.70	1.13	3.7	3.93	2.7	3.0	
0.55	M2VA	80 B	3GVA	083 002-***A	880	73.1	0.70	1.67	3.5	5.98	2.8	3.0	
0.75	M2AAM	90 S	3GAA	093 001-***A	920	70.6	0.72	2.3	3.9	7.1	1.7	2.0	
1.1	M2AAM	90 L	3GAA	093 002-***A	920	73.9	0.73	3.2	3.9	10.5	1.7	2.0	
1.5	M2AAM	100 L	3GAA	103 002-***A	940	79.0	0.74	3.96	4.3	14.3	1.7	2.0	
2.2	M3AA	112 M	3GAA	113 001-***C	930	80.0	0.80	5.4	5.2	23	1.9	2.4	
2.5	HO	M3AA	112 MB	3GAA	113 002-***C	945	81.0	0.75	6.3	6.3	25	2.6	3.0
3	M3AA	132 S	3GAA	133 001-***C	955	84.0	0.80	7	6.3	30	1.7	2.3	
4	M3AA	132 MA	3GAA	133 002-***C	955	85.0	0.82	9	6.5	40	2.1	2.5	
5.5	M3AA	132 MB	3GAA	133 003-***C	955	84.5	0.82	12.3	6.5	55	2.2	2.5	
6	HO	M3AA	132 MC	3GAA	133 004-***C	960	85.5	0.78	13.8	6.7	60	2.2	2.6
7.5	M3AA	160 M	3GAA	163 101-***C	960	88.5	0.80	16.1	6.2	84	1.8	2.5	
11	M3AA	160 L	3GAA	163 102-***C	960	89.4	0.80	23.5	7.0	113	2.1	2.9	
13.5	HO	M3AA	160 LB	3GAA	163 103-***C	965	89.7	0.77	30	8.3	134	3.2	3.7
15	M3AA	180 L	3GAA	183 101-***C	970	90.5	0.79	32	6.4	153	1.8	2.7	
16.5	HO	M3AA	180 LB	3GAA	183 102-***C	965	90.6	0.80	35	6.2	163	1.7	2.6
18.5	M3AA	200 MLA	3GAA	203 001-***C	980	90.8	0.81	38	6.1	185	2.2	2.4	
22	M3AA	200 MLB	3GAA	203 002-***C	980	91.6	0.81	45	6.2	225	2.3	2.4	
30	HO	M3AA	200 MLC	3GAA	203 003-***C	980	91.5	0.83	57	7.0	292	3.0	2.7
30	M3AA	225 SMB	3GAA	223 001-***C	985	92.6	0.83	59	6.0	291	2.3	2.4	
37	HO	M3AA	225 SMC	3GAA	223 002-***C	980	93.0	0.83	72	6.8	371	2.8	2.7
37	M3AA	250 SMA	3GAA	253 001-***C	985	93.5	0.84	72	6.6	359	2.5	2.5	
45	HO	M3AA	250 SMB	3GAA	253 002-***C	985	93.8	0.86	85	6.7	436	2.5	2.5
<b>Steel frame</b>													
45	M2CA	280 SA	3GCA	283 110-***A	988	94.0	0.83	89	6.0	435	2.3	2.2	
55	M2CA	280 SMA	3GCA	283 210-***A	988	94.4	0.84	106	6.0	532	2.2	2.2	
75	HO	M2CA	280 MB	3GCA	283 320-***A	988	94.5	0.86	144	6.7	725	2.6	2.5
90	HO	M2CA	280 MC	3GCA	283 330-***A	988	94.8	0.84	174	6.8	870	2.7	2.6
110	HO	M2CA	280 MD	3GCA	283 340-***A	987	95.1	0.84	210	7.2	1064	2.8	2.7
75	M2CA	315 SA	3GCA	313 110-***A	991	94.8	0.82	146	6.6	723	2.0	2.4	
90	M2CA	315 SMA	3GCA	313 210-***A	990	95.2	0.84	173	6.4	868	2.0	2.4	
110	M2CA	315 MB	3GCA	313 320-***A	990	95.1	0.84	212	6.5	1061	2.2	2.5	
132	M2CA	315 LA	3GCA	313 510-***A	988	95.3	0.84	252	6.0	1275	2.1	2.4	
160	HO	M2CA	315 LB	3GCA	313 520-***A	990	95.5	0.84	304	7.0	1543	2.6	2.7
200	HO	M2CA	315 LC	3GCA	313 530-***A	989	95.7	0.84	381	6.6	1931	2.4	2.6
132	M2CA	355 SA	3GCA	353 110-***A	991	95.2	0.86	245	6.0	1272	1.5	2.3	
160	M2CA	355 SB	3GCA	353 120-***A	991	95.8	0.86	295	6.2	1541	1.6	2.4	
200	M2CA	355 MA	3GCA	353 310-***A	992	95.8	0.86	370	6.8	1925	1.8	2.5	
250	M2CA	355 MB	3GCA	353 320-***A	990	95.8	0.82	485	6.6	2411	1.9	2.8	
315	M2CA	355 LKD	3GCA	353 540-***A	990	96.2	0.85	590	6.6	3038	1.8	2.7	
355	M2CA	400 MLA	3GCA	403 410-***A	991	96.3	0.86	650	5.8	3421	1.1	2.4	
400	M2CA	400 MLB	3GCA	403 420-***A	991	96.3	0.86	730	5.8	3854	1.1	2.5	
450	M2CA	400 LKA	3GCA	403 510-***A	992	96.5	0.86	825	6.1	4332	1.1	2.6	

HO = High output design (Cenelec +1)

The two bullets indicate a 2-letter product code supplement for choice of mounting arrangement, and voltage and frequency; see ordering information.

Output kW	Motor type	Speed r/min	Efficiency %	Power factor cosφ	Current		Torque			Moment of inertia J = 1/4GD <sup>2</sup> kgm <sup>2</sup>	Weight kg
					I <sub>N</sub> A	I <sub>s</sub> I <sub>N</sub>	T <sub>N</sub> Nm	T <sub>s</sub> T <sub>N</sub>	T <sub>max</sub> T <sub>N</sub>		
<b>1200 r/min = 6 poles 440 V 60 Hz</b>											
<b>Aluminium frame</b>											
0.10	M2VA 63 A	1090	44.1	0.58	0.51	2.1	0.87	1.9	1.9	0.000038	4
0.14	M2VA 63 B	1090	54.9	0.59	0.57	2.1	1.22	1.9	1.9	0.000044	4.5
0.18	HO M2VA 63 BB	1080	53.5	0.56	0.79	2.2	1.59	1.9	2.0	0.000051	5
0.25	M2VA 71 A	1100	62.6	0.75	0.7	2.9	2.17	1.6	1.7	0.00014	5.5
0.33	M2VA 71 B	1100	68.8	0.70	0.9	3.2	2.86	1.9	2.1	0.00015	6.5
0.43	HO M2VA 71 C	1100	67.2	0.70	1.2	3.2	3.73	1.9	2.1	0.00017	7
0.50	M2VA 80 A	1095	74.0	0.74	1.2	3.8	4.36	2.4	2.7	0.001842	9
0.70	M2VA 80 B	1080	72.9	0.70	1.8	3.4	6.2	2.3	2.5	0.002176	10
0.9	M2AAM 90 S	1105	70.6	0.72	2.3	3.9	7.1	1.7	2.0	0.0032	13
1.3	M2AAM 90 L	1105	73.9	0.73	3.2	3.9	10.3	1.7	2.0	0.0043	16
1.75	M2AAM 100 L	1130	79.0	0.74	3.96	4.3	13.9	1.7	2.0	0.0082	23
2.5	M3AA 112 M	1130	81.0	0.79	5.2	5.4	21	1.9	2.4	0.015	27
2.9	HO M3AA 112 MB	1145	82.5	0.73	6.3	6.3	24	2.5	2.9	0.018	33
3.5	M3AA 132 S	1155	85.5	0.80	6.9	6.4	29	1.7	2.3	0.031	39
4.6	M3AA 132 MA	1155	86.5	0.80	8.9	6.6	38	2.1	3.2	0.038	46
6.4	M3AA 132 MB	1155	84.5	0.81	12.1	6.6	45	2.2	2.9	0.045	54
6.9	HO M3AA 132 MC	1160	86.5	0.77	13.6	6.8	57	2.2	2.6	0.049	59
9.8	M3AA 160 M	1165	88.5	0.80	18.5	6.2	80	1.6	2.5	0.089	88
13	M3AA 160 L	1170	89.4	0.79	25	7.0	106	1.9	2.9	0.307	102
15.5	HO M3AA 160 LB	1165	89.7	0.77	30	8.3	127	2.9	3.7	0.127	117
17.5	M3AA 180 L	1165	90.5	0.79	33	6.4	143	1.6	2.7	0.217	151
19	HO M3AA 180 LB	1165	90.6	0.80	35	6.2	156	1.5	2.6	0.237	160
22	M3AA 200 MLA	1180	90.8	0.82	39	6.1	122	2.0	2.3	0.37	165
26	M3AA 200 MLB	1175	91.6	0.83	47	6.2	210	2.1	2.4	0.43	185
34	HO M3AA 200 MLC	1180	91.5	0.83	57	7.0	275	2.7	2.7	0.49	200
35	M3AA 225 SMB	1185	92.6	0.83	61	6.0	283	2.0	2.3	0.64	225
44	HO M3AA 225 SMC	1180	93.0	0.83	74	6.8	356	2.5	2.6	0.75	252
43	M3AA 250 SMA	1185	93.5	0.84	73	6.6	347	2.2	2.4	1.16	280
52	HO M3AA 250 SMB	1185	93.8	0.86	85	6.7	419	2.2	2.4	1.49	320
<b>Steel frame</b>											
55	M2CA 280 SA	1186	94.2	0.83	92	6.0	443	2.1	2.1	1.65	440
63	M2CA 280 SMA	1187	94.8	0.83	105	6.2	507	2.4	2.5	2	475
86	HO M2CA 280 MB	1188	94.7	0.84	143	6.9	691	2.5	2.5	2.6	545
105	HO M2CA 280 MC	1187	94.8	0.84	175	6.9	845	2.6	2.6	3.1	815
125	HO M2CA 280 MD	1188	95.2	0.84	206	7.6	1005	2.9	2.8	4.1	835
86	M2CA 315 SA	1190	94.8	0.83	144	6.8	690	2.0	2.5	2.9	630
105	M2CA 315 SMA	1190	95.0	0.84	172	6.5	843	2.0	2.4	3.8	720
125	M2CA 315 MB	1190	95.0	0.84	205	6.9	1003	2.2	2.5	4.5	805
150	M2CA 315 LA	1188	95.1	0.84	247	6.3	1206	2.2	2.5	5.4	910
185	HO M2CA 315 LB	1190	95.4	0.84	303	7.2	1485	2.5	2.7	7.3	1200
230	HO M2CA 315 LC	1189	95.5	0.84	380	6.9	1847	2.4	2.6	9.2	1380
160	M2CA 355 SA	1190	95.5	0.86	255	5.6	1284	1.4	2.2	8.7	1200
195	M2CA 355 SB	1190	96.0	0.86	310	5.9	1564	1.4	2.2	10	1320
230	M2CA 355 MA	1192	95.6	0.86	365	6.7	1842	1.7	2.5	13	1550
275	M2CA 355 MB	1190	95.8	0.82	460	6.8	2206	1.9	2.8	13	1550
340	M2CA 355 LKD	1190	96.0	0.85	550	7.2	2728	1.8	2.8	15	1900
400	M2CA 400 MLA	1191	96.2	0.86	630	5.8	3207	1.1	2.4	17	2400
440	M2CA 400 MLB	1191	96.3	0.86	695	5.9	3528	1.1	2.5	17	2400
500	M2CA 400 LKA	1192	96.5	0.86	795	6.3	4005	1.1	2.6	19	2700

# Technical data

## Marine motors with aluminium and steel frame

IP 55 - IC 411 - Temperature rise 90 K

Output kW	Motor type	Product code	Speed r/min	Efficiency %	Power factor cos φ	Current		Torque					
						$I_N$ A	$I_s$ $I_N$	$T_N$ Nm	$T_s$ $T_N$	$T_{max}$ $T_N$			
<b>750 r/min = 8 poles</b>			<b>380 V 50 Hz</b>										
<b>Aluminium frame</b>													
0.06	M2VA	63 B	3GVA	064 002-••A	675	41.2	0.50	0.44	1.7	0.78	2.0	2.0	
0.09	M2VA	71 A	3GVA	074 001-••A	680	46.3	0.60	0.5	2.1	1.25	2.1	2.1	
0.12	M2VA	71 B	3GVA	074 002-••A	680	47.7	0.57	0.65	2.1	1.67	2.3	2.3	
0.02	M2VA	80 A	3GVA	084 001-••A	690	61.1	0.57	0.8	3.1	2.49	2.9	3.3	
0.25	M2VA	80 B	3GVA	084 002-••A	675	70.2	0.60	0.91	2.9	3.55	2.7	2.9	
0.37	M2AAM	90 S	3GAA	094 001-••A	690	62.7	0.59	1.57	2.9	4.7	1.2	2.1	
0.55	M2AAM	90 L	3GAA	094 002-••A	680	64.9	0.61	2.27	3.0	7.0	1.4	1.8	
0.75	M2AAM	100 LA	3GAA	104 001-••A	690	72.0	0.63	2.5	3.9	9.5	1.9	2.4	
1.1	M2AAM	100 LB	3GAA	104 002-••A	700	74.0	0.68	3.3	3.9	14	1.9	2.4	
1.5		M3AA	112 M	3GAA	114 001-••C	690	73.0	0.71	4.5	3.8	21	1.6	2.2
1.8	HO	M3AA	112 MB	3GAA	114 002-••C	690	74.0	0.68	5.5	4.5	25	1.9	2.2
2.2		M3AA	132 S	3GAA	134 001-••C	705	79.5	0.73	5.8	5.3	30	1.7	2.2
3		M3AA	132 M	3GAA	134 002-••C	705	80.5	0.73	7.8	5.4	41	1.8	2.3
3.5	HO	M3AA	132 MB	3GAA	134 003-••C	710	80.5	0.71	9.4	5.2	47	2.0	2.3
4		M3AA	160 MA	3GAA	164 101-••C	710	81.1	0.71	10.2	4.0	61	1.3	1.9
5.5		M3AA	160 M	3GAA	164 102-••C	705	83.2	0.72	13.8	4.7	74	1.6	2.3
7.5		M3AA	160 L	3GAA	164 103-••C	710	85.5	0.72	18.6	5.4	102	2.1	2.4
11		M3AA	180 L	3GAA	184 101-••C	715	87.5	0.77	24.5	4.5	154	1.5	2.0
13.5	HO	M3AA	180 LB	3GAA	184 102-••C	715	86.8	0.80	30	4.6	180	1.5	2.1
15		M3AA	200 MLA	3GAA	204 001-••C	735	91.0	0.83	30	6.4	208	1.6	2.7
18.5	HO	M3AA	200 MLB	3GAA	204 002-••C	735	91.2	0.83	37	6.2	240	1.5	2.5
18.5		M3AA	225 SMA	3GAA	224 001-••C	730	91.0	0.79	39	5.6	242	1.7	2.4
22		M3AA	225 SMB	3GAA	224 002-••C	730	91.4	0.81	45	5.7	288	1.7	2.4
30	HO	M3AA	225 SMC	3GAA	224 003-••C	730	91.7	0.80	62	6.6	393	1.9	2.9
30		M3AA	250 SMA	3GAA	254 001-••C	735	92.6	0.81	61	6.3	390	1.7	2.6
37	HO	M3AA	250 SMB	3GAA	254 002-••C	735	92.5	0.82	74	6.6	481	1.8	2.6
<b>Steel frame</b>													
37		M2CA	280 SA	3GCA	284 110-••A	740	93.2	0.80	75	6.8	477	1.6	2.7
45		M2CA	280 SMA	3GCA	284 210-••A	740	93.8	0.80	92	7.3	581	1.7	2.9
55	HO	M2CA	280 MB	3GCA	284 320-••A	740	94.2	0.81	110	7.2	710	1.7	2.9
55		M2CA	315 SA	3GCA	314 110-••A	740	93.9	0.82	108	6.6	710	1.5	2.5
75		M2CA	315 SMA	3GCA	314 210-••A	739	94.3	0.82	148	6.5	969	1.6	2.5
90		M2CA	315 MB	3GCA	314 320-••A	739	94.6	0.83	175	6.7	1163	1.6	2.5
110		M2CA	315 LA	3GCA	314 510-••A	738	94.7	0.84	213	6.4	1423	1.6	2.4
110		M2CA	355 SA	3GCA	354 110-••A	740	94.5	0.80	220	5.2	1419	1.3	2.0
132		M2CA	355 MA	3GCA	354 310-••A	742	94.8	0.78	270	5.3	1698	1.4	2.1
160		M2CA	355 MB	3GCA	354 320-••A	741	95.1	0.80	320	5.9	2062	1.6	2.2
200		M2CA	355 LKD	3GCA	354 540-••A	742	95.5	0.79	410	5.9	2574	1.6	2.4
250		M2CA	400 MLA	3GCA	404 410-••A	743	96.0	0.79	500	6.6	3213	1.4	2.6
315		M2CA	400 LKA	3GCA	404 510-••A	743	96.1	0.80	620	6.4	4048	1.4	2.5

HO = High output design (Cenelec +1)

The two bullets indicate a 2-letter product code supplement for choice of mounting arrangement, and voltage and frequency; see ordering information.



Output kW	Motor type		Speed r/min	Efficiency %	Power factor cosφ	Current		Torque			Moment of inertia $J = \frac{1}{4}GD^2$ kgm <sup>2</sup>	Weight kg
						$I_N$ A	$I_s$ $I_N$	$T_N$ Nm	$T_s$ $T_N$	$T_{max}$ $T_N$		
<b>900 r/min = 8 poles</b>						<b>440 V 60 Hz</b>						
<b>Aluminium frame</b>												
0.07	M2VA	63 B	815	39.3	0.50	0.47	1.8	0.82	1.7	1.7	0.00004	4.5
0.12	M2VA	71 A	825	47.4	0.64	0.52	2.2	1.39	1.7	1.7	0.00014	5.5
0.18	M2VA	71 B	825	48.5	0.65	0.75	2.2	2.08	1.7	1.7	0.00015	6.5
0.25	M2VA	80 A	840	60.8	0.60	0.9	3.1	2.84	2.3	2.7	0.002176	10
0.32	M2VA	80 B	815	70.1	0.60	1.0	3.1	3.75	2.3	2.5	0.002427	10.5
0.45	M2AAM	90 S	830	62.7	0.59	1.57	2.9	4.7	1.2	2.1	0.0032	13
0.65	M2AAM	90 L	815	64.9	0.61	2.27	3.0	7	1.4	1.8	0.0043	16
0.9	M2AAM	100 LA	830	72.0	0.63	2.5	3.9	9.5	1.9	2.4	0.0069	20
1.3	M2AAM	100 LB	840	74.0	0.68	3.3	3.9	14	1.9	2.4	0.0082	23
1.7	M3AA	112 M	840	75.0	0.69	4.3	4.0	19.3	1.6	2.2	0.016	28
2.1	HO	M3AA 112 MB	840	76.0	0.66	5.5	4.5	24	1.9	2.2	0.018	33
2.5	M3AA	132 S	855	81.0	0.70	5.7	5.4	28	1.7	2.2	0.038	46
3.5	M3AA	132 M	855	82.0	0.73	7.8	5.4	39	1.8	2.2	0.045	53
4	HO	M3AA 132 MB	860	82.0	0.69	9.3	5.3	44	1.9	2.2	0.049	59
5.2	M3AA	160 MA	850	81.0	0.75	11.5	4.0	58	1.2	1.9	0.072	75
6.3	M3AA	160 M	860	83.2	0.72	14.5	4.7	70	1.5	2.3	0.091	88
8.6	M3AA	160 L	855	85.5	0.73	18.5	5.4	96	1.9	2.4	0.131	118
13.5	M3AA	180 L	865	87.5	0.80	25.5	4.5	149	1.3	1.9	0.224	147
15.5	HO	M3AA 180 LB	865	86.8	0.80	30	4.6	171	1.4	2.1	0.24	155
18	M3AA	200 MLA	885	91.0	0.84	32	6.4	194	1.5	2.7	0.45	175
21	HO	M3AA 200 MLB	885	91.2	0.83	37	6.2	227	1.4	2.5	0.54	200
21	M3AA	225 SMA	880	91.0	0.79	39	5.6	228	1.5	2.4	0.61	210
25	M3AA	225 SMB	880	91.4	0.81	45	5.7	271	1.7	2.4	0.68	225
34	HO	M3AA 225 SMC	880	91.7	0.80	62	6.6	369	1.7	2.9	0.8	255
34	M3AA	250 SMA	885	92.6	0.81	61	6.3	367	1.5	2.6	1.25	280
42	HO	M3AA 250 SMB	885	92.5	0.82	74	6.6	453	1.6	2.6	1.52	320
<b>Steel frame</b>												
43	M2CA	280 SA	890	93.9	0.81	75	6.7	461	1.5	2.7	1.85	460
55	M2CA	280 SMA	889	94.0	0.82	95	7.0	591	1.5	2.7	2.2	500
65	HO	M2CA 280 MB	889	94.5	0.82	110	7.1	698	1.5	2.8	2.85	575
63	M2CA	315 SA	889	94.0	0.82	107	6.5	677	1.4	2.4	2.9	630
85	M2CA	315 SMA	889	94.4	0.83	144	6.6	913	1.5	2.4	3.8	715
105	M2CA	315 MB	888	94.7	0.83	175	6.6	1129	1.5	2.4	4.5	800
125	M2CA	315 LA	888	94.8	0.84	206	6.5	1344	1.5	2.4	5.4	900
125	M2CA	355 SA	890	94.3	0.81	210	5.2	1341	1.2	2.0	8.7	1200
150	M2CA	355 MA	892	95.4	0.78	265	5.1	1605	1.3	2.1	10	1350
180	M2CA	355 MB	892	95.3	0.80	310	5.7	1927	1.4	2.0	13	1550
230	M2CA	355 LKD	892	95.3	0.79	405	5.9	2462	1.5	2.4	15	1900
285	M2CA	400 MLA	893	96.0	0.80	485	6.6	3047	1.3	2.6	17	2400
360	M2CA	400 LKA	893	96.1	0.80	610	6.4	3849	1.3	2.5	19	2700

# Technical data

## Marine motors with aluminium and steel frame, two speed

IP 55 - IC 411 - Temperature rise 90 K

Output kW	Motor type	Product code	Speed r/min	Efficiency %	Power factor cos φ	Current		Torque		
						$I_N$ A	$I_s$ $I_N$	$T_N$ Nm	$T_s$ $T_N$	$T_{max}$ $T_N$
<b>3000/1500 r/min = 2/4 poles <sup>1)</sup></b>			<b>380 V 50 Hz</b>			<b>Fan drive, two separate windings</b>				
1.3/0.22	M2AAM 090 S	3GAA 098 201-**-A	2865/1465	75.0/43.5	0.88/0.64	2.9/1.2	5.2/3.0	4.3/1.4	1.6/0.9	2.3/2.1
1.9/0.3	M2AAM 090 L	3GAA 098 202-**-A	2865/1465	77.0/55.0	0.89/0.69	4.2/1.2	5.2/3.4	6.3/1.9	1.7/0.9	2.3/2.1
2.4/0.4	M2AAM 100 L	3GAA 108 201-**-A	2895/1465	76.0/56.0	0.88/0.68	5.3/1.6	6.2/3.7	7.8/2.6	2.0/0.9	2.8/2.4
3.4/0.6	M3AA 112 M	3GAA 118 204-**-C	2880/1465	83.0/68.0	0.92/0.60	6.8/2.1	6.5/5.7	11.3/3.9	1.6/1.6	2.1/2.5
4.7/1.08	M3AA 132 S	3GAA 138 207-**-C	2900/1475	84.0/63.0	0.90/0.60	9.5/3.3	8.4/5.8	15.5/5.2	2.5/2.2	3.0/3.1
6.7/1.2	M3AA 132 M	3GAA 138 208-**-C	2875/1470	85.0/68.0	0.93/0.67	12.9/4.0	7.4/5.8	22/7.8	2.1/1.8	2.6/2.5
11.4/1.7	M3AA 160 M	3GAA 168 352-**-C	2940/1470	88.8/77.3	0.90/0.75	22/4.5	8.5/5.8	37/37	2.3/2.0	3.2/2.4
15.3/2.2	M3AA 160 L	3GAA 168 353-**-C	2940/1480	89.5/78.4	0.91/0.66	28/6.5	8.1/7.2	50/50	2.3/3.0	3.0/3.4
17.5/2.5	M3AA 180 M	3GAA 188 357-**-C	2935/1465	88.6/76.5	0.91/0.78	33/6.5	6.7/5.5	57/57	2.0/1.9	2.4/1.9
22/3.2	M3AA 180 L	3GAA 188 358-**-C	2940/1465	90.5/77.1	0.91/0.80	41/8	8.1/4.5	71/71	2.7/1.8	3.0/1.8
26/3.6	M3AA 200 MLA	3GAA 208 210-**-C	2945/1480	91.5/85.0	0.89/0.72	49/9.2	8.3/7.3	84/84	2.3/2.7	2.9/2.8
33/4.8	M3AA 200 MLB	3GAA 208 211-**-C	2945/1480	92.5/86.5	0.91/0.74	61/11.9	8.0/7.0	107/107	2.3/2.7	2.7/2.7
38/5.3	M3AA 225 SMB	3GAA 228 207-**-C	2950/1475	92.5/86.5	0.90/0.78	70/12.1	7.3/5.9	123/123	2.3/2.8	2.4/2.1
44/6.2	M3AA 225 SMC	3GAA 228 208-**-C	2955/1480	93.0/87.5	0.91/0.78	80/14	7.5/6.2	142/142	2.5/2.9	2.5/2.1
62/8.8	M3AA 250 SMB	3GAA 258 204-**-C	2965/1485	94.0/89.5	0.90/0.76	111/20	9.5/7.3	200/200	2.3/2.6	3.2/2.3
<b>3000/1500 r/min = 2-4 poles <sup>1)</sup></b>			<b>380 V 50 Hz</b>			<b>Fan drive, Dahlander-connection</b>				
1.4/0.33	M2AAM 090 S	3GAA 098 101-**-A	2855/1455	74.0/61.5	0.88/0.68	3.2/1.2	5.0/3.5	4.7/2.1	1.74/1	2.3/1.9
2.1/0.45	M2AAM 090 L	3GAA 098 102-**-A	2850/1455	78.0/69.0	0.89/0.66	4.6/1.5	5.6/4.0	7.0/2.9	2.0/1.1	2.5/2.0
2.4/0.47	M2AAM 090 LB	3GAA 098 103-**-A	2850/1455	77.0/71.0	0.89/0.63	5.3/1.6	5.8/4.0	8.0/3.1	2.1/1.3	2.3/2.1
3.0/0.6	M2AAM 100 L	3GAA 108 101-**-A	2865/1465	77.0/73.5	0.91/0.62	6.5/2.0	5.7/4.4	9.9/3.9	2.0/1.2	2.5/2.5
3.2/0.7	M2AAM 100 LB	3GAA 108 102-**-A	2880/1465	78.0/76.5	0.92/0.66	6.7/2.1	6.1/4.4	11/4.6	2.1/1.1	2.5/2.7
4.2/0.9	M3AA 112 M	3GAA 118 104-**-C	2875/1450	83.0/78.0	0.93/0.72	8.2/2.4	6.7/5.8	14/14	1.7/1.9	2.2/2.8
6/1.2	M3AA 132 S	3GAA 138 127-**-C	2865/1455	83.0/81.0	0.92/0.79	11.9/3.2	7.0/7.2	20/20	1.8/2.5	2.4/3.2
7.8/1.6	M3AA 132 M	3GAA 138 108-**-C	2875/1455	84.0/81.0	0.93/0.72	15/4.1	7.2/6.3	26/26	2.4/2.6	2.6/3.2
8.8/1.8	M3AA 160 MA	3GAA 168 301-**-C	2915/1465	84.0/81.6	0.90/0.71	18/5	5.8/5.5	29/29	1.4/2.0	2.2/2.3
14/2.8	M3AA 160 M	3GAA 168 302-**-C	2920/1465	86.4/84.1	0.92/0.74	27/7	6.2/5.6	46/46	1.6/2.1	2.2/2.4
17/4	M3AA 160 L	3GAA 168 303-**-C	2930/1465	88.6/86.4	0.91/0.74	32.5/9.5	7.5/5.7	55/55	2.1/2.2	2.8/2.5
18.9/4.1	M3AA 180 M	3GAA 188 305-**-C	2935/1470	88.9/87.1	0.92/0.76	35.5/9.5	6.9/5.5	62/62	2.0/2.1	2.5/2.3
22.8/4.6	M3AA 180 L	3GAA 188 306-**-C	2940/1470	89.8/88.1	0.92/0.75	42/10.5	7.5/5.9	74/74	2.1/2.2	2.6/2.5
28/7	M3AA 200 MLA	3GAA 208 110-**-C	2940/1465	90.0/89.0	0.89/0.85	53/15	7.3/6.4	91/91	2.1/2.1	2.6/2.3
34/8.8	M3AA 200 MLB	3GAA 208 111-**-C	2950/1475	91.5/91.0	0.89/0.85	63/18	7.7/6.4	110/110	2.1/2.1	2.7/2.4
379.7	M3AA 200 MLC	3GAA 208 112-**-C	2950/1470	92.5/91.0	0.89/0.77	70/21	7.9/5.7	120/120	2.3/2.1	3.1/2.5
40/11.4	M3AA 225 SMB	3GAA 228 107-**-C	2955/1475	93.0/91.5	0.92/0.82	71/23	7.5/5.5	129/129	2.0/2.1	2.6/2.2
48/13.2	M3AA 225 SMC	3GAA 228 108-**-C	2955/1475	93.5/92.5	0.91/0.82	86/27	7.5/5.5	155/155	2.1/2.0	2.7/2.3
66/22	M3AA 250 SMB	3GAA 258 104-**-C	2965/1475	94.5/93.0	0.92/0.82	116/44	9.1/5.6	213/213	2.4/2.1	3.2/2.3

Data for frame sizes 56 to 80 on request.

<sup>1)</sup> These pole number combinations on steel motors on request.

The two bullets indicate a 2-letter product code supplement for choice of mounting arrangement, and voltage and frequency; see product catalogue for details.

Output kW	Motor type	Speed r/min	Efficiency %	Power factor cos φ	Current		Torque			Moment of inertia J = 1/4GD <sup>2</sup> kgm <sup>2</sup>	Weight kg	
					$I_N$ A	$I_s$ A	$T_N$ Nm	$T_s$ Nm	$T_{max}$ Nm			
<b>3600 r/min = 2/4 poles<sup>1)</sup> 440 V 60 Hz</b>												
<b>Fan drive, two separate windings</b>												
1.56/0.27	M2AAM 090 S	3440/1760	75.0/43.5	0.88/0.64	2.9/1.2	5.2/3.0	4.1/1.3	1.5/0.85	2.3/2.0	0.0019	13	
2.3/0.36	M2AAM 090 L	3440/1760	77.0/55.0	0.89/0.69	4.2/1.2	5.2/3.4	6.0/1.8	1.6/0.85	2.2/2.0	0.0024	16	
2.9/0.5	M2AAM 100 L	3475/1760	76.0/56.0	0.88/0.68	5.3/1.6	6.2/3.7	7.5/2.4	1.9/0.85	2.7/2.3	0.0041	21	
4/0.7	M3AA 112 M	3480/1765	84.0/70.0	0.93/0.61	6.7/2	6.6/6.0	11/3.8	1.5/1.5	2.0/2.3	0.012	32	
5.5/1	M3AA 132 S	3500/1775	85.0/67.0	0.90/0.60	9.4/3.2	8.5/5.9	15/5.4	2.4/1.9	2.8/2.7	0.016	42	
7.7/1.4	M3AA 132 M	3480/1770	86.0/71.0	0.93/0.66	12.6/3.9	7.6/5.9	21.1/7.5	2.0/1.7	2.5/2.4	0.022	56	
13.1/2	M3AA 160 M	3540/1770	88.8/77.3	0.90/0.75	22/4.5	8.5/5.8	35/11	2.3/1.8	3.1/2.3	0.054	94	
17.6/2.5	M3AA 160 L	3540/1780	89.5/78.4	0.91/0.66	28/6.5	8.1/7.2	48/13	2.1/2.7	2.9/3.4	0.057	100	
20.1/2.9	M3AA 180 M	3535/1765	88.6/76.5	0.91/0.78	33/6.5	6.7/5.5	54/16	1.8/1.7	2.4/1.9	0.094	137	
25.3/3.7	M3AA 180 L	3540/1765	90.5/77.1	0.91/0.80	41/8	8.1/4.5	68/20	2.4/1.6	2.9/1.8	0.108	151	
30/4.2	M3AA 200 MLA	3545/1780	91.5/85.0	0.89/0.72	49/9.2	8.3/7.3	81/23	2.1/2.4	2.8/2.7	0.15	175	
38/5.6	M3AA 200 MLB	3545/1780	92.5/86.5	0.91/0.74	61/11.9	8.0/7.0	102/30	2.1/2.4	2.6/2.6	0.19	205	
44/6.1	M3AA 225 SMB	3550/1775	92.5/86.5	0.90/0.78	70/12.1	7.3/5.9	118/33	2.1/2.5	2.3/2.0	0.26	235	
51/7.2	M3AA 225 SMC	3555/1780	93.0/87.5	0.91/0.78	80/14	7.5/6.2	137/39	2.2/2.6	2.4/2.0	0.29	260	
72/10.2	M3AA 250 SMB	3565/1785	94.0/89.5	0.90/0.76	111/20	9.5/7.3	193/55	2.1/2.3	3.1/2.3	0.57	330	
<b>3600/1800 r/min = 2-4 poles<sup>1)</sup> 440 V 60 Hz</b>												
<b>Fan drive, Dahlander-connection</b>												
1.7/0.4	M2AAM 090 S	3426/1746	74.0/61.5	0.88/0.68	3.2/1.2	5.0/3.5	4.5/2.0	1.6/0.95	2.2/1.8	0.0019	13	
2.5/0.54	M2AAM 090 L	3420/1746	78.0/69.0	0.89/0.66	4.6/1.5	5.6/4.0	6.7/2.8	1.9/1.0	2.5/1.9	0.0024	16	
2.9/0.56	M2AAM 090 LB	3420/1746	77.0/71.0	0.89/0.63	5.3/1.6	5.8/4.0	7.7/3.0	2.0/1.2	2.2/2.0	0.0027	18	
3.6/0.72	M2AAM 100 L	3438/1758	77.0/73.5	0.91/0.62	6.5/2.0	5.7/4.4	9.5/3.7	1.9/1.1	2.4/2.4	0.0041	21	
3.8/0.8	M2AAM 100 LB	3456/1758	78.0/76.5	0.92/0.66	6.7/2.1	6.1/4.4	10.6/4.4	2.0/1.0	2.4/2.6	0.005	25	
4.8/1.1	M3AA 112 M	3440/1745	85.0/80.0	0.93/0.74	8/2.4	6.9/5.8	13.3/6	1.6/1.8	2.2/2.7	0.012	32	
6.9/1.4	M3AA 132 S	3470/1750	85.0/83.0	0.92/0.70	11.6/3.2	7.2/7.2	19/7.6	1.7/2.4	2.3/3.0	0.016	42	
9/1.9	M3AA 132 M	3480/1750	86.0/83.0	0.93/0.73	14.7/4.1	7.3/6.3	25/10.4	2.3/2.5	2.5/3.1	0.022	56	
10.1/2.1	M3AA 160 MA	3515/1765	84.4/81.6	0.90/0.71	18/5	5.8/5.5	27/11	1.3/1.8	2.2/2.5	0.039	73	
16.1/3.2	M3AA 160 M	3520/1765	86.4/84.1	0.92/0.74	27/7	6.2/5.6	44/17	1.4/1.9	2.2/2.4	0.054	94	
19.6/4.6	M3AA 160 L	3530/1765	88.6/86.4	0.91/0.74	32.5/9.5	7.5/5.7	53/25	1.9/2.0	2.7/2.5	0.057	100	
21.7/4.7	M3AA 180 M	3535/1770	88.9/87.1	0.92/0.76	35.5/9.5	6.9/5.5	59/25	1.8/1.9	2.5/2.3	0.094	137	
26.2/5.3	M3AA 180 L	3540/1770	89.8/88.1	0.92/0.75	42/10.5	7.5/5.9	71/29	1.9/2.0	2.6/2.5	0.108	151	
32/8.1	M3AA 200 MLA	3540/1765	90.0/89.0	0.89/0.85	53/15	7.3/6.4	86/44	1.9/1.9	2.6/2.3	0.29	180	
39/10.2	M3AA 200 MLB	3550/1775	91.5/91.0	0.89/0.85	63/18	7.7/6.4	105/55	1.9/1.9	2.7/2.3	0.34	205	
43/11.2	M3AA 200 MLC	3550/1770	92.5/91.0	0.89/0.77	69/21	7.9/5.7	116/60	2.0/1.9	3.0/2.5	0.19	205	
46/13.2	M3AA 225 SMB	3555/1775	93.0/91.5	0.92/0.82	71/23	7.5/5.5	124/71	1.8/1.9	2.5/2.2	0.26	235	
56/15.3	M3AA 225 SMC	3555/1775	93.5/92.5	0.91/0.82	86/27	7.6/5.5	148/82	1.9/1.8	2.7/2.2	0.29	260	
76/25	M3AA 250 SMB	3565/1775	94.5/93.0	0.92/0.92	116/44	9.1/5.6	204/135	2.2/1.9	3.1/2.3	0.57	330	

# Technical data

## Marine motors with aluminium and steel frame, two speed

IP 55 - IC 411 - Temperature rise 90 K

Output kW	Motor type	Product code	Speed r/min	Efficiency %	Power factor cos φ	Current			Torque		
						$I_N$ A	$I_s$ $I_N$		$T_N$ Nm	$T_s$ $T_N$	$T_{max}$ $T_N$
<b>1500/1000 r/min = 4/6 poles</b>			<b>380 V 50 Hz</b>			<b>Fan drive, two separate windings</b>					
1.0/0.3	M2AAM 090 S	3GAA 098 204-**-A	1390/935	68.5/49.5	0.85/0.71	2.6/1.3	3.8/2.4	6.8/3.0	1.6/0.9	2.0/1.5	
1.3/0.45	M2AAM 090 L	3GAA 098 205-**-A	1400/920	72.0/54.5	0.85/0.74	3.2/1.7	4.5/2.6	8.7/4.5	1.8/0.9	2.2/1.6	
2.0/0.6	M2AAM 100 LA	3GAA 108 203-**-A	1420/955	74.5/59.5	0.87/0.73	4.7/2.1	4.5/3.0	13.0/5.9	1.6/0.9	2.1/1.7	
2.2/0.8	M2AAM 100 LB	3GAA 108 204-**-A	1430/955	77.0/65.0	0.85/0.72	5.1/2.6	5.7/3.2	14.0/7.9	2.0/1.0	2.5/1.8	
2.9/0.9	M3AA 112 M	3GAA 118 205-**-C	1445/975	81.0/65.0	0.85/0.66	6.4/3.1	6.6/4.2	19.2/19.2	1.2/1.0	2.2/2.2	
4.2/1.4	M3AA 132 S	3GAA 138 229-**-C	1460/985	83.0/68.0	0.86/0.64	8.9/4.8	6.4/4.2	28/28	1.5/1.0	2.3/2.2	
5.5/1.8	M3AA 132 M	3GAA 138 230-**-C	1460/980	84.0/71.0	0.86/0.72	11.5/5.3	7.0/4.5	36/36	1.8/1.3	2.5/2.0	
9.2/3.1	M3AA 160 M	3GAA 168 354-**-C	1460/970	86.6/74.0	0.83/0.76	19.5/8.5	6.5/4.0	60/60	2.0/1.2	2.5/1.7	
12.7/4	M3AA 160 L	3GAA 168 355-**-C	1460/970	88.1/75.7	0.83/0.74	26.5/11	7.1/4.5	83/83	2.3/1.4	2.7/1.9	
14/4.4	M3AA 180 M	3GAA 188 359-**-C	1470/980	88.7/76.5	0.83/0.72	29/12	6.5/4.5	91/91	1.9/1.3	2.5/2.0	
17.6/5.7	M3AA 180 L	3GAA 188 360-**-C	1470/980	89.7/78.5	0.83/0.73	36/15	6.8/4.5	114/114	2.0/1.3	2.6/1.9	
20/6.3	M3AA 200 MLA	3GAA 208 213-**-C	1475/985	89.5/84.0	0.88/0.87	39/13.8	8.0/8.0	129/129	1.7/2.0	2.9/3.0	
26/7.9	M3AA 200 MLB	3GAA 208 214-**-C	1470/985	90.0/83.5	0.90/0.89	49/16.6	8.0/6.9	169/169	1.7/1.2	2.8/2.2	
31/11	M3AA 225 SMB	3GAA 228 209-**-C	1470/985	91.0/85.0	0.91/0.89	58/22	7.6/6.0	201/201	1.5/1.2	2.7/2.1	
37/12.3	M3AA 225 SMC	3GAA 228 210-**-C	1475/985	91.5/89.0	0.89/0.89	70/25	8.6/7.0	240/240	1.7/1.4	3.1/2.4	
55/16.3	M3AA 250 SMB	3GAA 258 205-**-C	1475/985	93.5/87.0	0.89/0.79	101/37	7.8/7.5	356/356	2.5/3.1	2.8/2.7	
60/18.5	M2CA 280 SA	3GCA 288 114-**-A	1485/990	93.3/78.5	0.84/0.78	116/41	7.1/6.7	386/386	2.0/2.6	2.7/2.3	
73/25	M2CA 280 SMA	3GCA 288 214-**-A	1486/990	93.8/89.0	0.85/0.78	141/56	7.4/7.0	469/469	2.3/2.8	2.7/2.4	
84/27	M2CA 280 MB	3GCA 288 324-**-A	1484/990	94.1/89.5	0.87/0.79	158/58	7.1/7.1	541/541	2.2/2.8	2.6/2.6	
110/32	M2CA 315 SMA	3GCA 318 214-**-A	1487/990	94.8/90.6	0.85/0.79	214/70	6.5/5.8	706/706	1.7/2.2	2.4/2.4	
125/38	M2CA 315 MB	3GCA 318 324-**-A	1488/991	95.2/91.9	0.86/0.78	232/81	6.5/6.2	802/802	1.8/2.4	2.4/2.5	
150/45	M2CA 315 LA	3GCA 318 514-**-A	1485/989	95.4/91.0	0.86/0.78	278/96	6.2/5.2	965/965	1.9/2.1	2.6/2.2	
180/55	M2CA 355 MA	3GCA 358 314-**-A	1488/990	95.3/92.8	0.90/0.82	320/110	7.0/6.8	1155/530	1.3/1.6	2.9/2.8	
240/75	M2CA 355 LA	3GCA 358 514-**-A	1487/988	95.7/92.0	0.90/0.85	425/145	7.7/6.0	1541/725	1.5/1.4	3.1/2.3	
<b>1500/750 r/min = 4/8 poles <sup>1)</sup></b>			<b>380 V 50 Hz</b>			<b>Fan drive, two separate windings</b>					
1.0/0.13	M2AAM 090S	3GAA 098 207-**-A	1390/695	66.0/35.0	0.85/0.71	2.7/0.8	3.5/1.9	6.8/1.8	1.4/0.9	1.8/1.5	
1.4/0.18	M2AAM 090 L	3GAA 098 208-**-A	1410/705	69.5/37.5	0.83/0.61	3.7/1.2	4.0/2.1	9.4/2.4	1.5/1.0	2.1/1.9	
1.65/0.25	M2AAM 100 LA	3GAA 108 206-**-A	1430/715	75.5/41.5	0.85/0.61	4.0/1.5	5.0/2.3	10.7/3.3	1.7/1.0	2.3/1.9	
2/0.33	M2AAM 100 LB	3GAA 108 207-**-A	1430/715	77.0/48.5	0.81/0.61	4.6/1.7	5.4/2.4	13/4.3	1.9/1.0	2.5/2.0	
2.7/0.4	M3AA 112 M	3GAA 118 206-**-C	1445/725	81.0/51.0	0.87/0.61	5.8/1.9	6.9/8.9	17.8/17.8	1.5/1.4	2.4/2.3	
4/0.6	M3AA 132 S	3GAA 138 231-**-C	1460/740	83.0/52.0	0.86/0.56	8.5/3.1	6.0/3.5	26/26	1.3/1.0	2.1/2.2	
5/0.7	M3AA 132 M	3GAA 138 232-**-C	1455/735	83.0/51.0	0.88/0.59	10.4/3.6	6.2/3.3	33/33	1.5/1.3	2.2/2.3	
7.8/1.2	M3AA 160 M	3GAA 168 356-**-C	1460/735	86.0/64.0	0.83/0.52	17/5.5	6.5/3.9	51/51	2.0/2.3	2.5/2.6	
11.4/1.6	M3AA 160 L	3GAA 168 357-**-C	1460/735	87.3/59.0	0.84/0.51	24/8	6.4/3.9	75/75	2.0/1.9	2.4/2.7	
14/2	M3AA 180 M	3GAA 188 361-**-C	1475/740	89.3/63.6	0.82/0.51	30/9.5	7.2/4.0	92/92	2.2/1.8	2.8/2.7	
16.7/2.4	M3AA 180 L	3GAA 188 362-**-C	1475/740	90.1/67.5	0.83/0.52	35/10	7.3/3.9	108/108	2.3/1.7	2.8/2.5	
23.2/0.9	M3AA 200 MLA	3GAA 208 216-**-C	1475/740	91.0/73.0	0.85/0.59	46/10.2	7.0/4.7	149/149	2.1/2.4	2.5/2.6	
26.3/0.3	M3AA 200 MLB	3GAA 208 217-**-C	1470/740	91.5/75.5	0.86/0.59	50/11.4	7.0/4.8	169/169	2.2/2.3	2.5/2.3	
33/4.6	M3AA 225 SMB	3GAA 228 211-**-C	1480/740	91.5/80.5	0.84/0.63	66/14	7.6/5.3	213/213	2.2/2.3	2.7/2.0	
40/6.2	M3AA 225 SMC	3GAA 228 212-**-C	1480/740	92.5/82.0	0.86/0.66	78/17.7	8.0/5.0	258/258	2.4/2.1	2.8/2.1	
55/8.8	M3AA 250 SMB	3GAA 258 206-**-C	1475/740	93.5/83.0	0.89/0.65	101/25	7.8/6.2	356/356	2.5/3.1	2.8/2.8	

Data for frame sizes 56 to 80 on request.

<sup>1)</sup> These pole number combinations on steel motors on request.

The two bullets indicate a 2-letter product code supplement for choice of mounting arrangement, and voltage and frequency; see product catalogue for details.

Output kW	Motor type	Speed r/min	Efficiency %	Power factor cos φ	Current		Torque			Moment of inertia J = 1/4GD <sup>2</sup> kgm <sup>2</sup>	Weight kg	
					I <sub>N</sub> A	I <sub>s</sub> A	T <sub>N</sub> Nm	T <sub>s</sub> Nm	T <sub>max</sub> Nm			
<b>1800/1200 r/min = 4/6 poles      440 V 60 Hz      Fan drive, two separate windings</b>												
1.2/0.36	M2AAM 090 S	1668/1122	68.5/49.5	0.85/0.71	2.6/1.3	3.8/2.4	6.5/2.8	1.5/0.85	2.0/1.4	0.0032	13	
1.56/0.54	M2AAM 090 L	1680/1104	72.0/54.5	0.85/0.74	3.2/1.7	4.5/2.6	8.4/4.3	1.7/0.85	2.1/1.5	0.0043	16	
2.4/0.72	M2AAM 100 LA	1704/1146	74.5/59.5	0.87/0.73	4.7/2.1	4.5/3.0	12.5/5.6	1.5/0.85	2.0/1.6	0.0069	20	
2.6/0.9	M2AAM 100 LB	1716/1146	77.0/65.0	0.85/0.72	5.1/2.6	5.7/3.2	13.5/7.5	1.9/0.95	2.4/1.7	0.0082	23	
3.3/1.1	M3AA 112 M	1750/1175	83.0/69.0	0.85/0.67	6.1/3.1	6.9/4.2	18/8.9	1.2/1.0	2.2/2.2	0.018	33	
4.8/1.6	M3AA 132 S	1760/1185	85.0/71.0	0.86/0.63	8.7/4.7	6.6/4.3	26/12.9	1.4/1.0	2.2/2.2	0.038	48	
6.3/2.1	M3AA 132 M	1760/1180	86.0/74.0	0.86/0.71	11.2/5.3	7.2/4.5	34/17	1.7/1.2	2.4/1.9	0.048	59	
10.5/3.6	M3AA 160 M	1760/1170	86.6/74.0	0.83/0.76	19.5/8.5	6.5/4.0	57/29	1.8/1.1	2.5/1.7	0.089	93	
14.6/4.6	M3AA 160 L	1760/1170	88.1/75.7	0.83/0.74	26.5/11	7.1/4.5	79/38	2.1/1.3	2.7/1.9	0.119	117	
16.1/5.1	M3AA 180 M	1770/1180	88.8/76.5	0.83/0.72	29/12	6.5/4.5	87/41	1.7/1.2	2.5/1.9	0.176	131	
20.2/6.6	M3AA 180 L	1770/1180	89.7/78.5	0.83/0.73	36/15	6.8/4.5	109/53	1.8/1.2	2.6/1.9	0.224	159	
23/7	M3AA 200 MLA	1775/1185	89.5/84.0	0.88/0.87	39/13.8	8.0/8.1	124/56	1.5/1.9	2.8/3.0	0.45	175	
30/9	M3AA 200 MLB	1770/1185	90.0/83.5	0.90/0.89	49/16.6	8.0/6.9	162/73	1.5/1.1	2.7/2.2	0.54	200	
36/13	M3AA 225 SMB	1770/1185	91.0/85.0	0.91/0.89	58/22	7.6/6.1	194/105	1.3/1.1	2.6/2.0	0.68	225	
43/14	M3AA 225 SMC	1775/1185	91.5/89.0	0.89/0.89	69/25	8.6/7.0	231/113	1.6/1.3	3.0/2.4	0.8	255	
64/19	M3AA 250 SMB	1775/1185	93.5/87.0	0.89/0.79	101/37	7.8/7.5	344/153	2.2/2.7	2.7/2.6	0.88	335	
69/21	M2CA 280 SA	1784/1190	93.3/88.5	0.85/0.78	116/41	7.2/7.2	369/169	1.9/2.8	2.7/2.4	1.15	445	
85/29	M2CA 280 SMA	1785/1190	93.9/89.5	0.85/0.78	140/56	7.6/7.4	455/233	2.1/2.9	2.7/2.5	1.4	490	
97/31	M2CA 280 MB	1784/1190	94.2/90.3	0.87/0.79	155/58	7.3/7.7	519/249	2.1/3.1	2.6/2.7	1.7	550	
125/38	M2CA 315 SMA	1787/1189	94.6/90.9	0.85/0.79	206/72	6.8/6.0	668/305	1.6/2.2	2.6/2.4	2.3	730	
140/42	M2CA 315 MB	1788/1191	95.2/92.2	0.86/0.78	226/77	6.8/7.0	748/337	1.7/2.7	2.5/2.8	2.9	850	
165/50	M2CA 315 LA	1786/1188	95.3/92.0	0.86/0.78	267/90	6.6/6.0	882/402	2.0/2.4	2.8/2.4	3.5	970	
210/65	M2CA 355 MA	1788/1190	95.1/92.6	0.90/0.82	320/110	7.0/6.8	1121/521	1.2/1.5	2.8/2.7	6.5	1350	
270/85	M2CA 355 LA	1787/1188	95.5/91.8	0.90/0.85	410/145	7.7/6.0	1443/683	1.4/1.3	3.0/2.2	7.8	1550	
<b>1800/900 r/min = 4/8 poles<sup>1)</sup>      440 V 60 Hz      Fan drive, two separate windings</b>												
1.2/0.16	M2AAM 090S	1668/834	66.0/35.0	0.85/0.71	2.7/0.8	3.5/1.9	6.5/1.7	1.3/0.85	1.8/1.4	0.0032	13	
1.7/0.2	M2AAM 090 L	1692/846	69.5/37.5	0.83/0.61	3.7/1.2	4.0/2.1	9.0/2.3	1.4/0.95	2.0/1.8	0.0043	16	
1.9/0.3	M2AAM 100 LA	1716/858	75.5/41.5	0.85/0.61	4.0/1.5	5.0/2.3	9.6/3.2	1.6/0.95	2.2/1.8	0.0069	20	
2.4/0.4	M2AAM 100 LB	1716/858	77.0/48.5	0.81/0.61	4.6/1.7	5.4/2.4	12.5/4.1	1.8/0.95	2.4/2.0	0.0082	23	
3.1/0.5	M3AA 112 M	1745/875	83.0/54.0	0.87/0.61	5.7/1.9	7.0/8.9	17/5.5	1.4/1.2	2.3/2.0	0.018	32	
4.6/0.7	M3AA 132 S	1760/890	85.0/56.0	0.86/0.54	8.3/3	6.1/3.7	25/7.5	1.3/1.0	2.0/2.1	0.038	48	
5.8/0.8	M3AA 132 M	1760/890	85.0/53.0	0.88/0.55	10.2/3.5	6.3/3.4	32/8.6	1.5/1.3	2.1/2.3	0.048	59	
9/1.4	M3AA 160 M	1760/885	86.0/64.0	0.83/0.52	17/5.5	6.5/3.9	51/15	1.7/2.0	2.3/2.5	0.089	92	
13.1/1.8	M3AA 160 L	1760/885	87.3/59.0	0.84/0.51	24/8	6.4/3.9	71/19	1.8/1.7	2.4/2.7	0.119	117	
16.1/2.3	M3AA 180 M	1775/890	89.3/63.6	0.82/0.51	30/9.5	7.2/4.0	87/25	2.0/1.6	2.8/2.7	0.176	130	
19.2/2.8	M3AA 180 L	1775/890	90.1/67.5	0.83/0.52	35/10	7.3/3.9	103/30	2.1/1.5	2.8/2.4	0.224	159	
27/3.4	M3AA 200 MLA	1775/890	91.0/73.0	0.85/0.59	46/10.2	7.0/4.7	143/36	1.9/2.2	2.5/2.5	0.28	180	
30/3.8	M3AA 200 MLB	1770/890	91.5/75.5	0.86/0.59	50/11.4	7.0/4.8	162/41	2.0/2.0	2.4/2.2	0.34	205	
38/5.3	M3AA 225 SMB	1780/890	91.5/80.5	0.84/0.63	66/14	7.6/5.3	205/57	1.9/2.1	2.6/2.3	0.41	230	
46/7.2	M3AA 225 SMC	1780/890	92.5/82.0	0.86/0.66	78/17.7	8.0/5.0	248/77	2.1/1.9	2.7/2.1	0.49	265	
64/10.2	M3AA 250 SMB	1775/890	93.5/83.0	0.89/0.65	101/25	7.8/6.2	342/109	2.2/2.7	2.7/2.7	0.89	335	

# Technical data

## Marine motors with aluminium and steel frame, two speed

IP 55 - IC 411 - Temperature rise 90 K

Output kW	Motor type	Product code	Speed r/min	Efficiency %	Power factor cos φ	Current		Torque		
						$I_N$ A	$I_s$ $I_N$	$T_N$ Nm	$T_s$ $T_N$	$T_{max}$ $T_N$
<b>1500/750 r/min = 4-8 poles</b>			<b>380 V 50 Hz</b>			<b>Fan drive, Dahlander-connection</b>				
1/0.26	M2AAM 090 S	3GAA 098104-**A	1410/695	71.0/47.5	0.81/0.64	2.7/1.3	4.2/2.2	6.8/3.6	1.8/1.1	2.3/1.7
1.4/0.35	M2AAM 090 L	3GAA 098105-**A	1400/695	74.0/54.0	0.83/0.58	3.5/1.7	5.0/2.3	8.5/4.7	2.4/1.3	2.8/1.9
1.5/0.35	M2AAM 090 LB	3GAA 098106-**A	1400/705	74.0/58.5	0.84/0.57	3.7/1.6	4.7/2.4	10/4.8	2.0/1.4	2.5/2.1
2/0.5	M2AAM 100 LA	3GAA 108103-**A	1420/710	75.0/62.5	0.85/0.61	4.8/2.0	4.8/2.5	13.5/6.7	1.9/1.1	2.5/1.7
2.5/0.6	M2AAM 100 LB	3GAA 108104-**A	1430/715	77.0/67.0	0.83/0.59	6.0/2.3	5.3/2.7	16/8.0	2.0/1.0	2.6/2.0
3.0/0.65	M2AAM 100 LC	3GAA 108105-**A	1420/715	76.5/66.5	0.83/0.57	7.2/2.6	5.0/2.7	20/8.7	2.0/1.2	2.5/2.1
3.3/0.7	M3AA 112 M	3GAA 118126-**C	1430/715	81.0/71.0	0.89/0.62	6.9/2.4	6.5/4.6	22/22	1.5/1.5	2.3/2.3
4.7/1	M3AA 132 S	3GAA 138131-**C	1450/730	83.0/74.0	0.88/0.62	9.8/3.3	6.1/3.6	31/31	1.4/0.9	2.2/1.8
6.1/1.3	M3AA 132 M	3GAA 138132-**C	1465/730	86.0/73.0	0.84/0.55	12.8/4.9	7.7/3.5	40/40	2.0/1.4	2.8/2.6
9.2/2	M3AA 160 M	3GAA 168304-**C	1460/730	87.4/76.2	0.82/0.53	19.5/7.5	7.1/3.6	60/60	2.2/1.4	2.8/2.2
13.6/2.4	M3AA 160 L	3GAA 168305-**C	1460/730	88.1/76.8	0.84/0.49	28.5/9.5	7.0/3.8	89/89	2.2/1.7	2.7/2.5
14.9/3	M3AA 180 M	3GAA 188307-**C	1470/735	88.8/78.7	0.85/0.55	30.5/10.5	6.5/3.4	97/97	1.7/1.2	2.3/1.9
19.3/3.9	M3AA 180 L	3GAA 188308-**C	1475/735	90.1/80.0	0.84/0.52	39/14.5	7.1/3.7	125/125	2.2/1.4	2.7/2.2
26/5.7	M3AA 200 MLA	3GAA 208116-**C	1470/730	90.5/86.0	0.86/0.64	51/15.7	6.9/4.3	169/169	2.2/1.9	2.4/1.9
29/7	M3AA 200 MLB	3GAA 208117-**C	1475/730	91.5/86.5	0.86/0.64	56/19.3	8.0/4.3	188/188	2.7/2.0	2.7/1.9
37/8.8	M3AA 225 SMB	3GAA 228111-**C	1480/740	92.0/89.5	0.78/0.61	79/25	8.0/5.1	239/239	2.6/2.3	3.1/2.4
44/9.7	M3AA 225 SMC	3GAA 228112-**C	1465/735	92.5/89.5	0.87/0.65	84/26	7.5/4.8	287/287	2.3/2.7	2.5/2.0
53/13.2	M3AA 250 SMB	3GAA 258106-**C	1475/735	93.0/90.0	0.86/0.70	97/31	8.1/4.8	343/343	2.7/2.2	2.8/2.1
65/15	M2CA 280 SA	3GCA 288119-**A	1482/741	93.1/90.0	0.85/0.64	124/40	6.9/4.7	419/419	2.4/2.4	2.6/2.1
77/20	M2CA 280 SMA	3GCA 288219-**A	1485/741	93.7/91.2	0.84/0.65	148/51	8.1/5.0	495/495	2.9/2.5	3.1/2.3
85/23	M2CA 280 MB	3GCA 288239-**A	1486/741	94.1/91.6	0.86/0.67	161/57	8.6/4.9	546/546	3.3/2.4	3.3/2.5
99/20	M2CA 315 SMA	3GCA 318219-**A	1487/744	94.5/92.4	0.85/0.62	187/53	6.8/4.9	636/636	1.9/2.1	2.6/2.5
120/23	M2CA 315 MB	3GCA 318329-**A	1486/746	94.8/92.9	0.86/0.64	224/59	6.8/4.8	771/771	2.0/2.0	2.6/2.4
144/29	M2CA 315 LA	3GCA 318519-**A	1486/743	95.1/93.3	0.86/0.64	268/74	7.0/4.8	925/925	2.1/2.1	2.7/2.5
180/36	M2CA 355 MA	3GCA 358319-**A	1488/744	95.1/93.6	0.89/0.67	320/90	7.5/5.1	1155/462	1.4/1.3	2.9/2.6
230/50	M2CA 355 LA	3GCA 358519-**A	1490/743	95.4/94.3	0.88/0.67	420/120	8.2/5.3	1474/642	1.6/1.4	3.3/2.5

Data for frame sizes 56 to 80 on request.

The two bullets indicate a 2-letter product code supplement for choice of mounting arrangement, and voltage and frequency; see product catalogue for details.

Output kW	Motor type	Speed r/min	Efficiency %	Power factor cos φ	Current		Torque			Moment of inertia J = 1/4GD <sup>2</sup> kgm <sup>2</sup>	Weight kg
					I <sub>N</sub> A	I <sub>s</sub> I <sub>N</sub>	T <sub>N</sub> Nm	T <sub>s</sub> T <sub>N</sub>	T <sub>max</sub> T <sub>N</sub>		
<b>1800/900 r/min = 4-8 poles</b>		<b>440 V 60 Hz</b>			<b>Fan drive, Dahlander-connection</b>						
1.2/0.3	M2AAM 090 S	1692/834	71.0/47.5	0.81/0.64	2.7/1.3	4.2/2.2	6.5/3.4	1.7/1.0	2.2/1.6	0.0032	13
1.7/0.4	M2AAM 090 L	1680/834	74.0/54.0	0.83/0.58	3.5/1.7	5.0/2.3	8.2/4.5	2.3/1.2	2.7/1.8	0.0043	16
1.8/0.4	M2AAM 090 LB	1680/846	74.0/58.5	0.84/0.57	3.7/1.6	4.7/2.4	9.6/4.6	1.9/1.3	2.4/2.0	0.0048	18
2.4/0.6	M2AAM 100 LA	1704/852	75.0/62.5	0.85/0.61	4.8/2.0	4.8/2.5	12.5/6.4	1.8/1.0	2.4/1.7	0.0069	20
3/0.72	M2AAM 100 LB	1716/858	77.0/67.0	0.83/0.59	6.0/2.3	5.3/2.7	15.4/7.6	1.9/0.95	2.5/1.9	0.0082	23
3.6/0.78	M2AAM 100 LC	1704/858	76.5/66.5	0.83/0.57	7.2/2.6	5.0/2.7	19.2/8.4	1.9/1.1	2.4/2.0	0.009	26
3.8/0.8	M3AA 112 M	1730/865	83.0/73.0	0.89/0.60	6.7/2.4	6.7/4.6	21/8.8	1.4/1.4	2.2/2.2	0.018	32
5.4/1.1	M3AA 132 S	1750/880	85.0/77.0	0.88/0.60	9.5/3.1	6.3/3.9	30/11.9	1.9/0.9	2.1/1.8	0.038	48
7/1.5	M3AA 132 M	1765/880	87.0/75.0	0.84/0.55	12.5/4.8	7.9/3.6	38/16.3	1.9/1.3	2.7/2.5	0.048	59
10.6/2.3	M3AA 160 M	1760/880	87.4/76.2	0.82/0.53	19.5/7.5	7.1/3.6	58/25	2.0/1.3	2.7/2.2	0.089	94
15.6/2.8	M3AA 160 L	1760/880	88.1/76.8	0.84/0.49	28.5/9.5	7.0/3.8	85/30	2.0/1.5	2.7/2.4	0.119	117
17.1/3.5	M3AA 180 M	1770/885	88.8/78.7	0.85/0.55	30.5/10.5	6.5/3.4	92/38	1.5/1.1	2.3/1.8	0.176	137
22.2/4.5	M3AA 180 L	1775/885	90.1/80.0	0.84/0.52	39/14.5	7.1/3.7	119/49	2.0/1.3	2.7/2.2	0.224	161
30/6.6	M3AA 200 MLA	1770/880	90.5/86.0	0.86/0.64	51/15.7	7.0/4.3	162/72	2.0/1.7	2.4/1.9	0.29	180
34/8.1	M3AA 200 MLB	1775/880	91.5/86.5	0.86/0.64	56/19.3	8.0/4.3	183/88	2.4/1.8	2.6/1.9	0.34	205
43/10.2	M3AA 225 SMB	1780/890	92.0/89.5	0.78/0.61	79/25	8.0/5.1	231/109	2.3/2.1	3.0/2.3	0.49	265
51/11.2	M3AA 225 SMC	1765/885	92.5/89.5	0.87/0.65	84/26	7.5/4.8	276/121	2.1/1.8	2.5/2.0	0.49	265
61/15.3	M3AA 250 SMB	1775/885	93.0/90.0	0.86/0.70	97/31	8.1/4.8	328/165	2.4/2.0	2.7/2.0	0.88	335
75/17.5	M2CA 280 SA	1783/891	93.2/90.5	0.86/0.64	123/40	7.0/4.8	402/188	2.2/2.4	2.6/2.1	1.15	445
88/23	M2CA 280 SMA	1785/891	93.8/91.7	0.85/0.65	145/51	8.4/5.1	471/247	2.8/2.5	3.2/2.3	1.4	490
98/27	M2CA 280 MB	1785/891	94.2/92.0	0.86/0.67	160/58	8.9/5.0	524/289	3.2/2.3	3.3/2.5	1.7	550
115/23	M2CA 315 SMA	1787/894	94.3/92.2	0.85/0.62	188/53	6.8/4.9	614/246	1.7/1.9	2.6/2.5	2.3	730
138/26	M2CA 315 MB	1786/893	94.6/92.7	0.86/0.64	223/58	6.8/4.8	739/277	1.8/1.8	2.6/2.4	2.9	850
165/33	M2CA 315 LA	1786/893	94.9/93.1	0.86/0.64	265/73	7.0/4.8	882/353	1.9/1.9	2.7/2.5	3.5	970
200/40	M2CA 355 MA	1788/894	94.9/93.4	0.89/0.67	310/85	7.5/5.1	1068/427	1.3/1.2	2.8/2.5	6.5	1350
260/55	M2CA 355 LA	1790/893	95.2/94.1	0.88/0.67	410/115	8.2/5.3	1387/588	1.5/1.3	3.2/2.4	7.8	1550

# Technical data

## Marine motors with aluminium and steel frame, two speed

IP 55 - IC 411 - Temperature rise 90 K

Output kW	Motor type	Product code	Speed r/min	Efficiency %	Power factor cos φ	Current		Torque			
						$I_N$ A	$I_s$ $I_N$	$T_N$ Nm	$T_s$ $T_N$	$T_{max}$ $T_N$	
<b>3000/1500 r/min = 2/4 poles<sup>1)</sup></b>						<b>380 V 50 Hz Constant torque, two separate windings</b>					
1.1/0.55	M2AAM 090 S	3GAA 098213-**-A	2890/1445	74.0/61.0	0.87/0.65	2.6/2.1	4.6/3.3	3.6/3.6	1.2/1.3	2.0/2.0	
1.5/0.75	M2AAM 090 L	3GAA 098214-**-A	2890/1445	73.0/67.0	0.89/0.68	3.5/2.5	5.2/3.7	4.9/4.9	1.3/1.3	2.2/2.0	
2.0/1.0	M2AAM 100 L	3GAA 118212-**-A	2890/1445	74.0/65.0	0.91/0.67	4.5/3.5	5.6/3.6	6.5/6.5	1.7/1.3	2.5/2.3	
2.6/1.3	M3AA 112 M	3GAA 118201-**-C	2885/1450	79.0/67.0	0.94/0.75	5.4/3.5	5.7/4.9	8.6/8.6	1.4/1.4	2.1/2.1	
3.7/1.9	M3AA 132 SB	3GAA 138201-**-C	2925/1455	82.0/76.0	0.87/0.70	7.9/5.4	8.0/4.6	12.1/12.1	2.1/1.4	2.5/2.3	
5.2/2.6	M3AA 132 M	3GAA 138202-**-C	2895/1445	83.0/78.0	0.93/0.75	10.3/6.8	6.6/4.9	17.2/17.2	1.7/1.4	2.0/2.1	
10.5/5.3	M3AA 160 M	3GAA 168359-**-C	2940/1465	87.5/83.8	0.91/0.78	20/12.5	8.1/6.2	34/34	2.2/2.4	2.9/2.5	
13.2/6.6	M3AA 160 L	3GAA 168360-**-C	2940/1465	89.7/84.5	0.91/0.77	25/16	8.2/6.2	43/43	2.2/2.5	3.0/2.5	
15.8/7.9	M3AA 180 L	3GAA 188352-**-C	2945/1465	88.9/83.7	0.91/0.77	30/19	7.9/5.3	51/51	2.4/2.1	2.8/2.1	
20/11	M3AA 200 MLA	3GAA 208201-**-C	2960/1475	90.0/89.0	0.89/0.85	38/22	8.1/7.3	65/65	1.8/2.1	2.9/2.4	
26/14	M3AA 200 MLB	3GAA 208202-**-C	2960/1475	91.0/90.0	0.90/0.87	48/28	8.5/7.5	84/84	1.9/2.3	3.0/2.6	
32/16	M3AA 225 SMB	3GAA 228201-**-C	2960/1480	91.5/91.5	0.91/0.76	59/36	8.1/7.3	103/103	2.5/3.9	2.7/2.5	
35/18	M3AA 225 SMC	3GAA 228202-**-C	2960/1475	92.0/91.5	0.91/0.79	64/39	8.8/6.5	113/113	2.9/3.3	2.9/2.2	
44/22	M3AA 250 SMC	3GAA 258201-**-C	2965/1485	93.0/93.0	0.91/0.76	80/48	9.1/8.7	142/142	2.2/3.6	3.0/3.0	
<b>3000/1500 r/min = 2-4 poles<sup>1)</sup></b>						<b>380 V 50 Hz Constant torque, Dahlander-connection</b>					
1.3/1.0	M2AAM 090 S	3GAA 098110-**-A	2700/1390	66.5/68.5	0.90/0.82	3.3/2.7	3.5/3.4	4.5/6.8	1.8/1.3	2.0/1.8	
1.9/1.5	M2AAM 090 L	3GAA 098111-**-A	2800/1410	74.5/71.5	0.84/0.78	4.6/4.1	4.6/4.0	6.4/10	2.5/1.8	2.7/2.2	
2.3/1.8	M2AAM 100 LA	3GAA 108109-**-A	2795/1435	68.0/75.0	0.89/0.82	5.8/4.5	4.7/4.6	7.8/12	2.1/1.7	2.5/2.3	
3/2.4	M2AAM 100 LB	3GAA 108110-**-A	2815/1430	77.0/77.0	0.88/0.86	6.7/5.3	5.4/5.5	11.7/15.5	2.2/1.9	2.5/2.5	
3.8/2.4	M3AA 112 M	3GAA 118101-**-C	2860/1430	81.0/78.0	0.94/0.76	7.5/6.1	6.0/6.2	12.7/12.7	1.8/2.2	2.2/2.7	
4.5/3	M3AA 132 SB	3GAA 138101-**-C	2825/1420	79.0/78.0	0.93/0.77	9.2/7.5	5.2/5.9	15.2/15.2	1.7/2.0	2.0/2.2	
6.9/4.6	M3AA 132 M	3GAA 138102-**-C	2865/1430	83.0/81.0	0.94/0.77	13.3/11.2	6.8/6.1	23/23	2.2/2.3	2.4/2.5	
7.9/5.7	M3AA 160 MA	3GAA 168306-**-C	2900/1445	83.0/82.0	0.91/0.71	16/15	4.9/4.2	26/26	1.2/1.7	1.9/1.9	
11/7.9	M3AA 160 M	3GAA 168307-**-C	2895/1440	85.1/85.1	0.92/0.79	21.5/18	4.9/4.3	36/36	1.3/1.6	1.8/1.7	
13.2/9.2	M3AA 160 L	3GAA 168308-**-C	2905/1445	86.5/86.2	0.92/0.78	25.5/21	5.5/4.7	43/43	1.4/1.8	2.0/1.9	
15.8/10.5	M3AA 180 M	3GAA 188301-**-C	2935/1465	88.4/88.1	0.92/0.75	30/24.5	6.9/5.7	51/51	2.0/2.4	2.5/2.4	
21/14.9	M3AA 180 L	3GAA 188302-**-C	2945/1465	89.9/88.8	0.92/0.74	39/35	8.0/5.8	68/68	2.5/2.6	2.8/2.5	
28/21	M3AA 200 MLA	3GAA 208101-**-C	2940/1470	89.0/90.5	0.89/0.86	53/41	7.0/6.1	91/91	1.9/2.2	2.5/2.2	
34/26	M3AA 200 MLB	3GAA 208102-**-C	2950/1470	90.5/91.0	0.84/0.86	69/50	7.0/7.0	110/110	1.8/2.2	2.7/2.4	
37/28	M3AA 225 SMB	3GAA 228101-**-C	2955/1475	92.5/93.0	0.92/0.88	66/53	7.3/6.7	120/120	1.5/2.0	2.6/2.4	
44/35	M3AA 225 SMC	3GAA 228102-**-C	2960/1475	92.5/93.0	0.84/0.87	87/65	7.6/7.3	142/142	1.8/2.1	2.9/2.6	
60/44	M3AA 250 SMC	3GAA 258101-**-C	2940/1475	93.0/93.5	0.93/0.88	105/81	6.8/7.1	195/195	1.5/2.2	2.4/2.6	
<b>1500/1000 r/min = 4/6 poles</b>						<b>380 V 50 Hz Constant torque, two separate windings</b>					
0.8/0.4	M2AAM 090 S	3GAA 098216-**-A	1420/945	64.5/55.0	0.82/0.66	2.3/1.7	3.5/3.2	5.3/4.0	1.3/1.6	1.9/2.3	
1.2/0.65	M2AAM 090 L	3GAA 098217-**-A	1420/940	68.5/63.0	0.83/0.67	3.2/2.4	4.0/3.3	8.0/6.6	1.5/1.5	2.0/2.2	
1.5/0.9	M2AAM 100 LA	3GAA 108214-**-A	1435/955	71.5/64.5	0.86/0.66	3.7/3.2	4.3/3.4	9.9/8.9	1.3/1.3	2.0/2.1	
1.8/1	M2AAM 100 LB	3GAA 108215-**-A	1455/960	74.5/68.0	0.80/0.66	4.6/3.5	5.3/3.9	11/10	1.9/1.6	2.7/2.5	
2.4/1.6	M3AA 112 M	3GAA 118202-**-C	1445/950	79.0/71.0	0.85/0.77	5.4/4.5	5.7/4.9	15.8/15.8	1.5/1.4	2.1/2.3	
3.3/2.2	M3AA 132 S	3GAA 138223-**-C	1465/980	82.0/74.0	0.85/0.70	7.3/6.3	6.3/6.0	22/22	1.3/1.1	2.2/2.2	
4.2/2.9	M3AA 132 M	3GAA 138224-**-C	1470/975	82.0/78.0	0.85/0.70	9.1/7.9	7.0/5.4	27/27	1.4/1.4	2.2/2.4	
6.6/4.8	M3AA 160 M	3GAA 168361-**-C	1470/970	84.8/80.0	0.79/0.72	14.5/12	7.5/5.0	43/43	2.2/1.7	3.0/2.1	
10/7.4	M3AA 160 L	3GAA 168362-**-C	1470/970	86.7/82.7	0.80/0.71	21/18.5	8.0/5.5	65/65	2.5/2.1	3.1/2.4	
11.4/7	M3AA 180 M	3GAA 188353-**-C	1470/975	87.2/81.4	0.82/0.75	24.5/17.5	6.7/4.5	71/71	1.9/1.4	2.5/1.8	
13.2/8.8	M3AA 180 L	3GAA 188354-**-C	1475/975	88.4/83.1	0.83/0.74	27.5/22	6.7/4.5	86/86	1.9/1.4	2.5/1.9	
16/11	M3AA 200 MLA	3GAA 208204-**-C	1475/985	88.5/86.0	0.91/0.86	31/23	7.7/7.7	104/104	2.1/2.6	2.5/2.6	
20/13	M3AA 200 MLB	3GAA 208205-**-C	1480/985	89.5/86.5	0.89/0.87	38/27	8.1/7.8	129/129	2.4/2.7	2.8/2.6	
22/15	M3AA 200 MLC	3GAA 208206-**-C	1475/980	89.0/85.5	0.87/0.88	44/30	7.9/6.7	142/142	2.4/2.3	2.7/2.2	
28/18	M3AA 225 SMB	3GAA 228203-**-C	1480/985	90.0/89.5	0.88/0.86	53/36	8.9/8.4	181/181	2.4/2.5	2.9/2.8	
32/21	M3AA 225 SMC	3GAA 228204-**-C	1480/985	90.5/90.0	0.88/0.87	62/41	8.5/7.6	206/206	2.2/2.3	2.8/2.6	
44/28	M3AA 250 SMB	3GAA 258202-**-C	1475/985	92.5/90.5	0.89/0.80	82/60	7.7/7.3	285/285	2.4/3.2	2.7/2.7	
50/32	M2CA 280 SA	3GCA 289114-**-A	1487/987	92.2/90.8	0.83/0.78	101/69	7.3/6.3	321/321	2.2/2.6	2.8/2.2	
60/40	M2CA 280 SMA	3GCA 289214-**-A	1488/988	92.7/91.8	0.83/0.77	119/86	7.7/6.8	385/385	2.3/2.9	3.0/2.3	
68/45	M2CA 280 MB	3GCA 289324-**-A	1488/989	93.2/92.4	0.85/0.78	130/94	7.6/7.1	436/436	2.3/3.1	2.9/2.3	
81/54	M2CA 315 SMA	3GCA 319214-**-A	1488/990	94.2/93.4	0.86/0.77	152/114	5.9/5.8	520/520	1.5/2.6	2.3/2.4	
99/67	M2CA 315 MB	3GCA 319324-**-A	1490/989	94.8/93.8	0.86/0.79	185/137	6.8/5.6	635/635	1.9/2.7	2.6/2.3	
120/80	M2CA 315 LA	3GCA 319514-**-A	1489/990	95.0/94.0	0.85/0.76	226/172	6.7/6.0	770/770	1.9/3.1	2.7/2.7	
140/93	M2CA 315 LB	3GCA 319524-**-A	1491/990	95.2/94.4	0.85/0.79	265/190	7.4/5.8	896/896	2.1/2.8	2.7/2.3	
180/120	M2CA 355 MA	3GCA 359314-**-A	1486/992	95.0/94.2	0.90/0.82	320/237	6.8/6.8	1156/1155	1.2/1.7	2.7/2.9	
210/140	M2CA 355 LA	3GCA 359514-**-A	1488/990	95.1/94.3	0.89/0.82	380/275	7.6/6.9	1347/1350	1.3/1.7	3.3/2.9	

Data for frame sizes 56 to 80 on request.

<sup>1)</sup> These pole number combinations on steel motors on request.



Output kW	Motor type	Speed r/min	Efficiency %	Power factor cos φ	Current		Torque			Moment of inertia J = 1/4 GD <sup>2</sup> kgm <sup>2</sup>	Weight kg
					I <sub>N</sub> A	I <sub>s</sub> I <sub>N</sub>	T <sub>N</sub> Nm	T <sub>s</sub> T <sub>N</sub>	T <sub>max</sub> T <sub>N</sub>		
<b>3600/1800 r/min = 2/4 poles<sup>1)</sup> 440 V 60 Hz</b>					<b>Constant torque, two separate windings</b>						
1.32/0.66	M2AAM 090 S	3468/534	74.0/61.0	0.87/0.65	2.6/2.1	4.6/3.3	3.5/3.4	1.1/1.2	1.9/1.9	0.0019	13
1.8/0.9	M2AAM 090 L	3468/534	73.0/67.0	0.89/0.68	3.5/2.5	5.2/3.7	4.7/4.7	1.2/1.2	2.1/2.0	0.0024	16
2.4/1.2	M2AAM 100 L	3468/534	74.0/65.0	0.91/0.67	4.5/3.5	5.6/3.6	6.3/6.3	1.6/1.2	2.4/2.2	0.0041	21
3/1.5	M3AA 112 M	3485/1750	81.0/78.0	0.94/0.74	5.2/3.4	6.0/5.0	8.2/8.2	1.4/1.4	2.0/2.0	0.012	32
4.2/2.1	M3AA 132 SB	3525/1755	84.0/79.0	0.87/0.68	7.6/5.2	8.3/4.8	11.4/11.4	2.1/1.4	2.5/2.3	0.016	42
6/3	M3AA 132 M	3495/1745	85.0/80.0	0.93/0.75	10/6.6	6.8/5.0	16.4/16.4	1.6/1.4	1.9/2.0	0.022	57
12/6.1	M3AA 160 M	3540/1765	87.5/83.8	0.91/0.78	20/12.5	8.1/6.2	32/33	2.0/2.2	2.2/2.4	0.055	94
15.2/7.6	M3AA 160 L	3540/1765	89.7/84.5	0.91/0.77	25/16	8.2/6.2	41/41	2.0/2.2	2.2/2.5	0.057	100
18.2/9.1	M3AA 180 L	3545/1765	88.9/83.7	0.91/0.77	30/19	7.9/5.3	49/49	2.2/1.9	2.4/2.1	0.108	151
23/12.7	M3AA 200 MLA	3560/1775	90.0/89.0	0.89/0.85	38/22	8.1/7.3	62/68	1.6/1.9	2.9/2.3	0.29	180
30/16.2	M3AA 200 MLB	3560/1775	91.0/90.0	0.90/0.87	48/28	8.5/7.5	81/87	1.7/2.1	2.9/2.5	0.34	205
37/18.5	M3AA 225 SMB	3560/1780	91.5/91.5	0.91/0.76	59/36	8.1/7.3	99/99	2.2/3.5	2.6/2.4	0.26	235
40/21	M3AA 225 SMC	3560/1775	92.0/91.5	0.91/0.79	64/39	8.8/6.5	107/113	2.6/2.9	2.9/2.1	0.29	260
51/25	M3AA 250 SMC	3565/1785	93.0/93.0	0.91/0.76	80/48	9.1/8.7	137/134	2.0/3.3	2.9/3.0	0.51	330
<b>3600/1800 r/min = 2-4 poles<sup>1)</sup> 440 V 60 Hz</b>					<b>Constant torque, Dahlander-connection</b>						
1.56/1.2	M2AAM 090 S	3240/468	66.5/68.5	0.90/0.82	3.3/2.7	3.5/3.4	4.3/6.5	1.7/1.2	1.9/1.7	0.0032	13
2.3/1.8	M2AAM 090 L	3360/492	74.5/71.5	0.84/0.78	4.6/4.1	4.6/4.0	6.1/9.6	2.3/1.7	2.6/2.1	0.0043	16
2.75/2.2	M2AAM 100 LA	3354/522	68.0/75.0	0.89/0.82	5.8/4.5	4.7/4.6	7.5/11.5	2.0/1.6	2.4/2.2	0.0069	20
3.6/2.9	M2AAM 100 LB	3378/516	77.0/77.0	0.88/0.86	6.7/5.3	5.4/5.5	10.5/5.3	2.1/1.8	2.4/2.4	0.0082	23
4.4/2.8	M3AA 112 M	3460/1730	82.0/80.0	0.94/0.77	7.4/5.9	6.1/6.4	12.1/15.5	1.7/2.1	2.2/2.6	0.012	32
5.2/3.5	M3AA 132 SB	3425/1720	80.0/80.0	0.93/0.77	9.1/7.4	5.3/5.9	14.5/19.4	1.6/1.9	2.0/2.2	0.016	42
8/5.3	M3AA 132 M	3465/1730	85.0/83.0	0.94/0.76	13.2/11	6.8/6.2	22/29	2.1/2.2	2.4/2.5	0.022	56
9.1/6.6	M3AA 160 MA	3500/1745	83.0/82.0	0.91/0.71	16/15	4.9/4.2	25/36	1.1/1.5	1.9/1.9	0.039	73
12.7/9.1	M3AA 160 M	3495/1740	85.1/85.1	0.92/0.79	21.5/18	4.9/4.3	35/50	1.2/1.4	1.3/1.6	0.054	94
15.2/10.6	M3AA 160 L	3505/1745	86.5/86.2	0.92/0.78	25.5/21	5.5/4.1	41/58	1.3/1.6	1.4/1.8	0.057	100
18.7/12	M3AA 180 M	3535/1765	88.4/88.1	0.92/0.75	30/24.5	6.9/5.7	51/65	1.7/2.2	1.9/2.4	0.094	137
24.2/17.1	M3AA 180 L	3545/1765	89.9/88.8	0.92/0.74	39/35	8.0/5.8	65/93	2.2/2.3	2.5/2.6	0.108	151
32/24	M3AA 200 MLA	3540/1770	89.0/90.5	0.89/0.86	53/41	7.0/6.1	86/130	1.7/2.0	2.5/2.2	0.29	180
39/30	M3AA 200 MLB	3550/1770	90.5/91.0	0.84/0.86	69/50	7.0/7.1	105/162	1.6/2.0	2.7/2.4	0.34	205
43/32	M3AA 225 SMB	3555/1775	92.5/93.0	0.92/0.88	66/52	7.3/6.7	116/172	1.3/1.8	2.5/2.4	0.42	230
51/40	M3AA 225 SMC	3560/1775	92.5/93.0	0.84/0.87	87/65	7.6/7.3	137/215	1.6/1.9	2.8/2.6	0.49	265
69/51	M3AA 250 SMC	3540/1775	93.0/93.5	0.93/0.88	105/81	6.8/7.1	188/275	1.3/2.0	2.4/2.5	0.88	335
<b>1800/1200 r/min = 4/6 poles 440 V 60 Hz</b>					<b>Constant torque, two separate windings</b>						
0.95/0.5	M2AAM 090 S	1704/1134	64.5/55.0	0.82/0.66	2.3/1.7	3.5/3.2	5.0/3.8	1.2/1.5	1.8/2.2	0.0032	13
1.44/0.78	M2AAM 090 L	1704/1128	68.5/63.0	0.83/0.67	3.2/2.4	4.0/3.3	7.7/6.4	1.4/1.4	1.9/2.0	0.0043	16
1.8/1	M2AAM 100 LA	1722/1146	71.5/64.5	0.86/0.66	3.7/3.2	4.3/3.4	9.5/8.5	1.2/1.2	1.9/2.0	0.0069	20
2.2/1.2	M2AAM 100 LB	1746/1152	74.5/68.0	0.80/0.66	4.6/3.5	5.3/3.9	10.5/9.6	1.8/1.5	2.6/2.4	0.0082	23
2.8/1.9	M3AA 112 M	1745/1150	81.0/74.0	0.85/0.76	5.3/5.4	5.8/4.1	15.3/15.8	1.4/1.3	2.1/2.3	0.018	33
3.7/2.5	M3AA 132 S	1765/1180	83.0/76.0	0.84/0.68	7/6.1	6.6/6.2	20/20	1.3/1.1	2.2/2.2	0.038	48
4.8/3.3	M3AA 132 M	1770/1175	84.0/80.0	0.85/0.70	8.8/7.6	7.3/5.7	26/27	1.3/1.3	2.1/2.3	0.048	59
7.6/5.5	M3AA 160 M	1770/1170	84.8/80.0	0.79/0.72	14.5/12	7.5/5.0	41/45	2.0/1.5	2.2/1.7	0.089	93
11.5/8.5	M3AA 160 L	1770/1170	86.7/82.7	0.80/0.71	21/18.5	8.0/5.5	62/69	2.2/1.9	2.5/2.1	0.119	117
13.1/8.1	M3AA 180 M	1770/1175	87.2/81.4	0.82/0.75	24.5/17.5	6.7/4.5	71/66	1.6/0.8	1.8/0.9	0.176	131
15.2/10.1	M3AA 180 L	1775/1175	88.4/83.1	0.83/0.74	27.5/22	6.7/4.5	82/82	1.7/1.3	1.9/1.4	0.224	159
19/13	M3AA 200 MLA	1775/1185	88.5/86.0	0.91/0.86	31/23	7.7/7.7	102/105	1.8/2.3	2.4/2.5	0.43	185
23/15	M3AA 200 MLB	1780/1185	89.5/86.5	0.89/0.87	38/27	8.1/7.8	123/121	2.2/2.4	2.7/2.5	0.49	200
25/17	M3AA 200 MLC	1775/1180	89.0/85.5	0.87/0.88	44/30	7.9/6.7	135/138	2.2/2.1	2.6/2.2	0.49	200
32/21	M3AA 225 SMB	1780/1185	90.0/89.5	0.88/0.86	53/36	8.9/8.4	172/169	2.2/2.2	2.9/2.7	0.64	225
37/24	M3AA 225 SMC	1780/1185	90.5/90.0	0.88/0.87	62/41	8.5/7.6	199/194	2.0/2.1	2.7/2.6	0.75	250
51/32	M3AA 250 SMB	1775/1185	92.5/90.5	0.89/0.80	82/60	7.7/7.3	275/258	2.1/2.9	2.6/2.7	0.88	335
58/37	M2CA 280 SA	1787/1187	92.3/91.5	0.83/0.78	100/68	7.5/6.6	310/298	2.0/2.6	2.8/2.3	1.15	445
69/46	M2CA 280 SMA	1788/1188	92.9/92.4	0.83/0.77	117/84	8.0/7.3	369/369	2.2/3.0	3.0/2.4	1.4	490
78/52	M2CA 280 MB	1788/1188	93.3/92.8	0.86/0.79	128/94	7.9/7.4	417/418	2.3/3.1	3.0/2.4	1.7	550
93/62	M2CA 315 SMA	1788/1190	94.0/93.2	0.86/0.77	151/113	5.9/5.8	497/497	1.4/2.4	2.3/2.4	2.3	730
115/77	M2CA 315 MB	1790/1189	94.6/93.6	0.86/0.79	185/137	6.8/5.6	613/618	1.7/2.4	2.6/2.3	2.9	850
138/92	M2CA 315 LA	1789/1190	94.8/93.8	0.85/0.76	225/170	6.7/6.0	737/738	1.7/2.7	2.7/2.7	3.5	970
160/108	M2CA 315 LB	1790/1190	95.0/94.2	0.85/0.79	260/191	7.2/5.8	853/867	1.9/2.5	2.7/2.3	3.9	1000
210/140	M2CA 355 MA	1786/1192	94.8/94.0	0.90/0.82	325/240	6.8/6.8	1123/1121	1.1/1.6	2.6/2.8	6.5	1350
240/160	M2CA 355 LA	1788/1190	94.9/94.1	0.89/0.82	375/270	7.6/6.9	1281/1284	1.2/1.6	3.2/2.8	7.8	1550

The two bullets indicate a 2-letter product code supplement for choice of mounting arrangement, and voltage and frequency; see product catalogue for details.

# Technical data

## Marine motors with aluminium and steel frame, two speed

IP 55 - IC 411 - Temperature rise 90 K

Output kW	Motor type	Product code	Speed r/min	Efficiency %	Power factor cos φ	Current		Torque		
						$I_N$ A	$I_s$ $I_N$	$T_N$ Nm	$T_s$ $T_N$	$T_{max}$ $T_N$
<b>1500/750 r/min = 4/8 poles <sup>1)</sup></b>			<b>380 V 50 Hz</b>			<b>Constant torque, two separate windings</b>				
0.55/0.25	M2AAM 090 S	3GAA 098 219-**-A	1445/695	52.0/48.5	0.80/0.60	2.0/1.3	3.8/2.1	3.6/3.4	1.1/1.2	2.0/1.9
0.65/0.37	M2AAM 090 L	3GAA 098 220-**-A	1450/695	65.0/54.0	0.76/0.58	2.0/1.8	4.3/2.3	4.3/5.0	1.4/1.3	2.5/2.0
1/0.55	M2AAM 100 LA	3GAA 108 217-**-A	1460/705	66.0/58.5	0.78/0.62	3.0/2.3	4.2/2.4	7.8/7.4	1.2/1.0	2.3/1.7
1.3/0.65	M2AAM 100 LB	3GAA 108 218-**-A	1440/700	71.0/60.0	0.82/0.60	3.4/2.7	4.8/2.8	8.5/8.7	1.3/1.2	2.3/2.0
1.7/0.9	M3AA 112 M	3GAA 118 203-**-C	1460/710	76.0/66.0	0.86/0.71	3.9/2.9	6.9/4.1	11.1/11.1	1.1/1.4	2.1/2.1
2.5/1.3	M3AA 132 S	3GAA 138 225-**-C	1470/730	80.0/70.0	0.82/0.62	5.9/4.6	6.1/4.3	16.2/16.2	1.4/1.3	2.3/2.4
3.3/1.7	M3AA 132 M	3GAA 138 226-**-C	1470/725	81.0/71.0	0.86/0.70	7.3/5.2	7.4/4.6	21/21	1.6/1.6	2.4/2.0
4.8/2.4	M3AA 160 M	3GAA 168 363-**-C	1465/730	83.6/70.1	0.82/0.57	11/9.5	6.5/4.0	31/31	1.8/1.8	2.5/2.3
7.9/4	M3AA 160 L	3GAA 168 364-**-C	1465/730	86.3/72.6	0.82/0.56	17/15	7.0/4.2	52/52	2.1/2.1	2.7/2.4
12.3/6.2	M3AA 180 L	3GAA 188 356-**-C	1475/735	88.1/76.2	0.82/0.56	26/22	7.1/4.0	80/80	2.0/1.8	2.7/2.2
16/8.3	M3AA 200 MLA	3GAA 208 207-**-C	1475/730	89.5/82.5	0.85/0.65	32/24	7.6/4.4	104/104	2.3/1.9	2.6/1.8
19/9.7	M3AA 200 MLB	3GAA 208 208-**-C	1480/735	90.5/83.0	0.84/0.60	38/30	8.8/4.8	123/123	2.7/2.5	3.0/2.3
25/12.3	M3AA 225 SMB	3GAA 228 205-**-C	1480/735	90.0/85.5	0.85/0.61	50/36	7.8/5.0	161/161	2.1/2.5	2.7/2.3
30/15	M3AA 225 SMC	3GAA 228 206-**-C	1480/735	92.0/87.0	0.86/0.66	59/40	8.1/4.9	194/194	2.2/2.3	2.8/2.0
44/22	M3AA 250 SMB	3GAA 258 203-**-C	1480/740	92.5/88.0	0.87/0.60	83/63	8.8/6.2	284/284	2.7/3.6	3.1/3.0
<b>1500/750 r/min = 4-8 poles</b>			<b>380 V 50 Hz</b>			<b>Constant torque, Dahlander-connection</b>				
0.7/0.34	M2AAM 090 S	3GAA 098 113-**-A	1410/700	68.5/49.0	0.82/0.57	1.9/1.8	4.0/2.3	4.7/4.7	1.4/1.6	2.0/2.2
1/0.45	M2AAM 090 L	3GAA 098 114-**-A	1390/690	71.0/53.0	0.85/0.58	2.5/2.3	4.1/2.5	6.7/6.2	1.4/1.6	2.0/2.3
1.5/0.75	M2AAM 100 LA	3GAA 108 112-**-A	1435/705	73.0/58.0	0.87/0.58	3.6/3.4	4.2/2.5	10.0/10.0	1.2/1.3	2.0/2.0
2.0/0.9	M2AAM 100 LB	3GAA 108 113-**-A	1435/710	75.0/62.0	0.88/0.56	4.6/4.0	4.4/2.8	13.0/11.3	1.2/1.5	2.0/2.2
2.2/1.3	M3AA 112 M	3GAA 118 103-**-C	1425/710	78.0/67.0	0.89/0.64	4.7/4.6	5.7/4.1	14.7/14.7	1.4/1.5	2.1/2.5
3.6/1.8	M3AA 132 S	3GAA 138 125-**-C	1450/730	83.0/72.0	0.87/0.55	7.6/6.9	5.4/3.9	24/24	1.3/1.2	2.0/2.6
5/2.5	M3AA 132 M	3GAA 138 126-**-C	1450/730	84.0/75.0	0.89/0.57	10.1/9	6.2/4.8	33/33	1.5/1.8	2.1/2.5
7/4	M3AA 160 M	3GAA 168 309-**-C	1440/725	84.1/76.1	0.86/0.60	15/13.5	4.6/3.4	46/46	1.3/1.3	1.8/1.8
10.5/6.2	M3AA 160 L	3GAA 168 310-**-C	1445/725	86.5/78.4	0.86/0.59	21.5/20.5	5.2/3.5	69/69	1.5/1.4	2.0/1.9
14/7	M3AA 180 L	3GAA 188 304-**-C	1460/730	88.4/79.8	0.86/0.54	28.5/25	4.8/3.5	92/92	1.2/1.4	1.8/2.0
19/11	M3AA 200 MLA	3GAA 208 107-**-C	1475/735	87.5/86.0	0.81/0.69	41/29	6.8/6.3	123/123	2.1/2.7	2.7/2.9
22/13	M3AA 200 MLB	3GAA 208 108-**-C	1475/735	89.0/86.0	0.86/0.67	44/35	7.8/6.2	142/142	2.3/2.7	2.8/2.8
26/15	M3AA 200 MLC	3GAA 208 109-**-C	1475/735	90.0/88.0	0.91/0.75	49/35	7.2/6.2	168/168	2.2/2.7	2.4/2.5
31/19	M3AA 225 SMB	3GAA 228 105-**-C	1475/735	90.0/89.0	0.90/0.74	59/45	6.8/5.8	201/201	1.7/2.1	2.2/2.3
37/22	M3AA 225 SMC	3GAA 228 106-**-C	1475/735	91.0/89.5	0.91/0.75	69/50	7.0/6.1	240/240	1.8/2.2	2.3/2.3
48/29	M3AA 250 SMB	3GAA 258 103-**-C	1480/740	92.0/90.5	0.90/0.75	89/66	7.5/6.6	310/310	2.2/2.6	2.6/2.6
50/32	M2CA 280 SA	3GCA 289 119-**-A	1484/742	92.9/92.3	0.89/0.73	92/71	6.7/6.7	321/321	1.8/2.4	2.4/2.4
65/40	M2CA 280 SMA	3GCA 289 219-**-A	1483/742	92.9/92.5	0.89/0.72	120/92	7.0/6.7	419/419	1.9/2.7	2.5/2.5
78/50	M2CA 280 MB	3GCA 289 329-**-A	1487/742	93.9/93.0	0.89/0.71	142/114	8.4/7.3	501/501	2.4/2.9	2.9/2.6
90/58	M2CA 315 SMA	3GCA 319 219-**-A	1487/742	94.1/93.7	0.89/0.74	163/127	6.5/6.3	578/578	1.5/2.1	2.6/2.5
108/68	M2CA 315 MB	3GCA 319 329-**-A	1486/742	94.4/94.0	0.90/0.74	193/148	7.5/6.5	694/694	1.7/2.2	2.6/2.6
135/85	M2CA 315 LA	3GCA 319 519-**-A	1486/742	94.6/94.1	0.89/0.72	244/191	7.2/6.5	868/868	2.0/2.4	2.8/2.6
150/90	M2CA 355 MA	3GCA 359 319-**-A	1490/740	94.0/93.0	0.90/0.74	275/205	6.5/3.4	961/1161	1.2/1.0	2.3/1.9
180/120	M2CA 355 LA	3GCA 359 519-**-A	1486/741	95.0/94.5	0.90/0.73	320/265	6.5/4.5	1156/1546	1.3/1.3	2.6/2.0

Data for frame sizes 56 to 80 on request.

<sup>1)</sup> These pole number combinations on steel motors on request.

The two bullets indicate a 2-letter product code supplement for choice of mounting arrangement, and voltage and frequency; see product catalogue for details.

Output kW	Motor type	Speed r/min	Efficiency %	Power factor cos φ	Current		Torque			Moment of inertia J = 1/4GD <sup>2</sup> kgm <sup>2</sup>	Weight kg
					I <sub>N</sub> A	I <sub>s</sub> A	T <sub>N</sub> Nm	T <sub>s</sub> Nm	T <sub>max</sub> Nm		
<b>1800/900 r/min = 4/8 poles<sup>1)</sup></b>		<b>440 V 60 Hz</b>			<b>Constant torque, two separate windings</b>						
0.6/0.3	M2AAM 090 S	1734/834	52.0/48.5	0.80/0.60	2.0/1.3	3.8/2.1	3.5/3.3	1.0/1.1	1.9/1.8	0.0032	13
0.7/0.4	M2AAM 090 L	1740/834	65.0/54.0	0.76/0.58	2.0/1.8	4.3/2.3	4.1/4.8	1.3/1.2	2.4/1.9	0.0043	16
1.2/0.66	M2AAM 100 LA	1752/846	66.0/58.5	0.78/0.62	3.0/2.3	4.2/2.4	7.5/7.1	1.1/0.95	2.3/1.6	0.0069	20
1.56/0.78	M2AAM 100 LB	1728/840	71.0/60.0	0.82/0.60	3.4/2.7	4.8/2.8	8.1/8.3	1.2/1.1	2.2/1.9	0.0082	23
2/1.1	M3AA 112 M	1760/860	78.0/80.0	0.86/0.71	3.9/2.9	6.9/4.1	10.9/12.2	1.1/1.3	2.0/1.9	0.018	32
2.9/1.5	M3AA 132 S	1770/880	82.0/73.0	0.81/0.61	5.8/4.4	6.2/4.5	15.6/16.3	1.4/1.3	2.2/2.3	0.038	48
3.8/1.9	M3AA 132 M	1770/875	83.0/74.0	0.85/0.68	7.1/5	7.6/4.8	21/21	1.6/1.6	2.3/2.0	0.048	59
5.5/2.8	M3AA 160 M	1765/880	83.6/70.1	0.82/0.57	11/9.5	6.5/4.0	30/30	1.6/1.6	2.5/2.2	0.089	92
9.1/4.6	M3AA 160 L	1765/880	86.3/72.6	0.82/0.56	17/4.2	7.0/4.2	49/50	1.9/1.9	2.7/2.4	0.119	117
14.1/7.1	M3AA 180 L	1775/885	88.1/76.2	0.82/0.56	26/22	7.1/4.0	76/77	1.8/1.6	2.7/2.2	0.225	159
19/9.6	M3AA 200 MLA	1775/880	89.5/82.5	0.85/0.65	32/24	7.6/4.4	102/104	2.0/1.7	2.5/1.8	0.29	180
22/11.2	M3AA 200 MLB	1780/885	90.5/83.0	0.84/0.60	38/30	8.8/4.8	118/121	2.4/2.2	2.9/2.2	0.34	205
29/14.2	M3AA 225 SMB	1780/885	90.0/85.5	0.85/0.61	50/36	7.8/5.0	156/153	1.9/2.2	2.6/2.3	0.42	230
35/17.4	M3AA 225 SMC	1780/885	92.0/87.0	0.86/0.66	58/40	8.1/4.9	188/188	1.9/2.0	2.7/1.9	0.49	265
51/25	M3AA 250 SMB	1780/890	92.5/88.0	0.87/0.60	83/63	8.8/6.2	274/268	2.4/3.3	3.0/3.0	0.89	335
<b>1800/900 r/min = 4-8 poles</b>		<b>440 V 60 Hz</b>			<b>Constant torque, Dahlander-connection</b>						
0.84/0.4	M2AAM 090 S	1692/840	68.5/49.0	0.82/0.57	1.9/1.8	4.0/2.3	4.5/4.5	1.3/1.5	1.9/2.1	0.0032	13
1.2/0.54	M2AAM 090 L	1668/828	71.0/53.0	0.85/0.58	2.5/2.3	4.1/2.5	6.4/5.9	1.3/1.5	1.9/2.2	0.0043	16
1.8/0.9	M2AAM 100 LA	1722/846	73.0/58.0	0.87/0.58	3.6/3.4	4.2/2.5	9.6/9.6	1.1/1.2	1.9/1.9	0.0069	20
2.4/1	M2AAM 100 LB	1722/852	75.0/62.0	0.88/0.56	4.6/4.0	4.4/2.8	12.5/10.8	1.1/1.4	1.9/2.1	0.0082	23
2.5/1.5	M3AA 112 M	1730/860	81.0/70.0	0.88/0.63	4.6/4.4	5.9/4.3	13.8/16.7	1.3/1.4	2.1/2.5	0.018	32
4.2/2.1	M3AA 132 S	1745/880	85.0/75.0	0.87/0.55	7.5/6.6	5.5/4.1	23/23	1.2/1.1	1.9/2.5	0.038	48
5.8/2.9	M3AA 132 M	1750/880	86.0/78.0	0.89/0.57	10/8.6	6.3/5.0	32/32	1.5/1.7	2.0/2.4	0.048	59
8/4.6	M3AA 160 M	1740/875	84.1/76.1	0.86/0.60	15/13.5	4.6/3.4	44/50	1.2/1.2	1.8/1.8	0.089	92
12.1/7.1	M3AA 160 L	1745/875	86.5/78.4	0.86/0.59	21.5/20.5	5.2/3.5	66/78	1.3/1.3	2.0/1.9	0.119	117
16.1/8	M3AA 180 L	1760/880	88.4/79.8	0.86/0.54	28.5/25	4.8/3.5	87/87	1.1/1.3	1.8/2.0	0.224	159
22/12.7	M3AA 200 MLA	1775/885	87.5/86.0	0.81/0.69	41/28	6.8/6.3	118/137	1.9/2.4	2.6/2.8	0.37	165
25/15	M3AA 200 MLB	1775/885	89.0/86.0	0.86/0.67	44/35	7.8/6.3	135/162	2.1/2.4	2.8/2.7	0.43	185
30/17.4	M3AA 200 MLC	1775/885	90.0/88.0	0.91/0.75	49/35	7.3/6.2	161/188	2.0/2.4	2.3/2.4	0.49	200
36/22	M3AA 225 SMB	1775/885	90.0/89.0	0.90/0.74	59/45	6.8/5.8	194/238	1.5/1.9	2.1/2.2	0.64	225
43/25	M3AA 225 SMC	1775/885	91.0/89.5	0.91/0.75	69/50	7.0/6.1	231/270	1.6/2.0	2.2/2.3	0.75	250
56/34	M3AA 250 SMB	1780/890	92.0/90.5	0.90/0.75	89/66	7.6/6.6	301/365	1.9/2.3	2.5/2.5	1.49	320
58/37	M2CA 280 SA	1784/892	92.7/92.5	0.89/0.73	92/72	6.7/6.7	310/396	1.7/2.4	2.4/2.4	1.85	460
75/46	M2CA 280 SMA	1784/892	93.1/93.0	0.89/0.73	119/90	7.1/7.0	401/492	1.8/2.6	2.5/2.5	2.2	500
90/58	M2CA 280 MB	1786/892	93.9/93.5	0.90/0.73	140/113	8.6/7.6	481/261	2.3/2.9	2.9/2.6	2.85	575
104/67	M2CA 315 SMA	1787/892	93.9/93.5	0.89/0.74	163/127	6.5/6.3	556/717	1.4/1.9	2.6/2.5	4.1	755
124/78	M2CA 315 MB	1786/892	94.2/93.8	0.90/0.74	192/147	7.5/6.5	663/835	1.5/2.0	2.6/2.6	4.9	845
155/98	M2CA 315 LA	1786/892	94.4/93.9	0.89/0.72	242/190	7.2/6.5	829/1049	1.8/2.2	2.8/2.6	5.8	950
170/100	M2CA 355 MA	1790/890	93.8/92.8	0.90/0.74	265/190	6.5/3.4	907/1073	1.1/0.9	2.2/1.8	6.5	1350
210/140	M2CA 355 LA	1786/891	94.8/94.3	0.90/0.73	325/265	6.5/4.5	1123/1500	1.2/1.2	2.5/1.9	7.8	1550

# Technical data

## Marine motors with cast iron frame

IP 55 - IC 411 - Temperature rise 90 K

Output kW	Motor type	Product code	Speed r/min	Effi- ciency %	Power factor cos φ	Current		Torque			
						I <sub>N</sub> A	I <sub>s</sub> I <sub>N</sub>	T <sub>N</sub> Nm	T <sub>s</sub> T <sub>N</sub>	T <sub>max</sub> T <sub>N</sub>	
<b>3000 r/min = 2 poles</b>						<b>380 V 50 Hz</b>					
0.4	M2BA 71 M2 A	3GBA 071 310-...C	2770	67.0	0.82	1.1	4.3	1.4	2.3	2.4	
0.6	M2BA 71 M2 B	3GBA 071 320-...C	2790	71.0	0.83	1.5	4.6	2.1	2.3	2.4	
0.8	M2BA 80 M2 A	3GBA 081 310-...C	2830	77.0	0.88	1.8	5.5	2.7	2.5	2.1	
1.2	M2BA 80 M2 B	3GBA 081 320-...C	2835	80.0	0.88	2.6	5.7	4	2.6	2.3	
1.6	M2BA 90 S2 A	3GBA 091 110-...C	2850	81.5	0.88	3.4	6.2	5.4	2.6	2.5	
2.3	M2BA 90 L2 A	3GBA 091 510-...C	2840	84.0	0.88	4.7	6.7	7.7	2.8	3.0	
3.2	M2BA 100 L2 A	3GBA 101 510-...C	2870	85.0	0.88	6.5	7.0	10.6	2.7	3.1	
4.2	M2BA 112 M2 A	3GBA 111 310-...C	2880	85.0	0.89	8.4	7.4	13.9	2.5	3.0	
5.8	M2BA 132 S2 A	3GBA 131 110-...C	2900	87.0	0.88	11.5	6.7	19.1	2.5	3.0	
8	M2BA 132 S2 B	3GBA 131 120-...C	2900	87.5	0.89	15.6	6.9	26.3	2.5	3.1	
11	M3BP 160 MA	3GBP 161 101-...A	2885	88.7	0.90	24	5.2	41	1.7	2.2	
15	M3BP 160 M	3GBP 161 102-...A	2905	91.1	0.90	27.5	5.5	51	1.9	2.1	
18.5	M3BP 160 L	3GBP 161 103-...A	2910	92.1	0.91	33.5	6.3	61	2.3	2.5	
21	HO M3BP 160 LB	3GBP 161 104-...A	2915	92.0	0.92	38	6.9	69	2.4	2.6	
22	M3BP 180 M	3GBP 181 101-...A	2930	91.6	0.90	40.5	5.7	75	2.1	2.4	
30	HO M3BP 180 LB	3GBP 181 102-...A	2940	93.1	0.90	55	7.5	101	2.8	3.0	
30	M3BP 200 MLA	3GBP 201 001-...A	2955	93.1	0.89	55	6.6	97	3.2	2.5	
37	M3BP 200 MLB	3GBP 201 002-...A	2950	93.4	0.89	68	6.5	120	2.3	2.9	
45	HO M3BP 200 MLC	3GBP 201 003-...A	2945	93.5	0.89	82	6.6	147	2.3	2.9	
45	M3BP 225 SMB	3GBP 221 001-...A	2955	93.7	0.89	82	6.4	151	2.3	2.5	
55	HO M3BP 225 SMC	3GBP 221 002-...A	2950	94.2	0.89	100	6.1	184	2.2	2.6	
55	M3BP 250 SMA	3GBP 251 001-...A	2960	94.3	0.89	100	6.6	184	1.8	2.7	
75	HO M3BP 250 SMB	3GBP 251 002-...A	2965	95.0	0.90	134	6.6	241	1.9	2.7	
75	M2BA 280 SMA	3GBA 281 210-...A	2974	94.8	0.89	137	6.7	241	1.8	2.6	
90	M2BA 280 SMB	3GBA 281 220-...A	2970	95.2	0.90	159	6.5	289	1.8	2.4	
110	HO M2BA 280 SMC	3GBA 281 230-...A	2974	95.7	0.91	193	7.5	353	2.1	2.8	
110	M3BP 315 SMA	3GBP 311 210-...G	2980	95.1	0.87	202	6.9	353	1.8	2.7	
132	M3BP 315 SMB	3GBP 311 220-...G	2980	95.4	0.89	238	6.7	423	2.0	2.7	
160	M3BP 315 SMC	3GBP 311 230-...G	2979	96.1	0.90	282	6.8	513	2.1	2.7	
200	M3BP 315 MLA	3GBP 311 410-...G	2977	96.3	0.90	354	7.0	642	2.3	2.7	
250	M2BA 355 S	3GBA 351 100-...A	2978	96.0	0.92	430	6.0	802	1.2	2.8	
315	M2BA 355 SMA	3GBA 351 210-...A	2975	96.5	0.92	540	6.7	1011	1.2	3.0	
400	M2BA 355 MLA	3GBA 351 410-...A	2980	96.5	0.92	690	6.9	1282	1.5	3.0	
400	M2BA 400 M	3GBA 401 300-...A	2980	96.5	0.92	690	6.9	1282	1.5	3.0	
430	M2BA 400 MA	3GBA 401 310-...A	2976	96.5	0.92	735	7.2	1380	1.2	3.0	
430	M2BA 355 MLC	3GBA 351 430-...A	2976	96.5	0.92	735	7.2	1380	1.2	3.0	
470	M2BA 400 LKA	3GBA 401 510-...A	2976	96.5	0.92	790	6.6	1508	0.7	2.8	
560	M2BA 400 LKB	3GBA 401 520-...A	2981	96.7	0.92	965	6.4	1794	0.6	3.0	

<sup>1)</sup> On request.

**HO** = High output design (Cenelec +1)

The two bullets indicate a 2-letter product code supplement for choice of mounting arrangement, and voltage and frequency; see ordering information.

Output kW	Motor type	Speed r/min	Effi- ciency %	Power factor cos φ	Current		Torque			Moment of inertia J = 1/4 GD <sup>2</sup> kgm <sup>2</sup>	Weight kg
					I <sub>N</sub> A	I <sub>s</sub> I <sub>N</sub>	T <sub>N</sub> Nm	T <sub>s</sub> T <sub>N</sub>	T <sub>max</sub> T <sub>N</sub>		
<b>3600 r/min = 2 poles</b>		<b>440 V 60 Hz</b>									
0.5	M2BA 71 M2 A	3370	67.0	0.83	1.2	4.3	1.4	2.3	2.4	0.00031	11
0.7	M2BA 71 M2 B	3390	71.0	0.84	1.5	4.6	2	2.3	2.4	0.0004	11
0.9	M2BA 80 M2 A	3430	77.0	0.89	1.7	5.5	2.5	2.5	2.1	0.00097	17
1.3	M2BA 80 M2 B	3435	80.0	0.89	2.4	5.7	3.6	2.6	2.3	0.0012	18
1.8	M2BA 90 S2 A	3450	81.5	0.89	3.3	6.2	5	2.6	2.5	0.0015	22
2.7	M2BA 90 L2 A	3440	84.0	0.89	4.7	6.7	7.5	2.8	3.0	0.002	25
3.7	M2BA 100 L2 A	3470	85.0	0.89	6.4	7.0	10.2	2.7	3.1	0.0044	34
4.9	M2BA 112 M2 A	3480	85.0	0.90	8.4	7.4	13.4	2.5	3.0	0.0075	45
6.7	M2BA 132 S2 A	3500	87.0	0.90	11.2	6.7	18.3	2.5	3.0	0.013	61
9.1	M2BA 132 S2 B	3500	87.5	0.90	15.2	6.9	24.8	2.5	3.1	0.016	68
15	M3BP 160 MA	3485	88.7	0.90	24	5.2	40	1.5	2.1	0.039	105
18	M3BP 160 M	3505	91.1	0.91	28.5	5.5	48	1.7	2.1	0.047	118
21	M3BP 160 L	3510	92.1	0.92	33.5	6.3	57	2.1	2.3	0.053	133
24	HO M3BP 160 LB	3515	92.0	0.92	38	6.9	65	2.2	2.6	0.058	140
26	M3BP 180 M	3520	91.6	0.90	42.5	5.7	72	2.1	2.4	0.077	178
35	HO M3BP 180 LB	3540	93.1	0.91	56	7.5	96	2.5	3.0	0.092	194
35	M3BP 200 MLA	3555	93.1	0.89	55	6.6	94	2.7	2.4	0.15	250
43	M3BP 200 MLB	3550	93.4	0.89	68	6.5	116	2.0	2.8	0.18	270
52	HO M3BP 200 MLC	3545	93.5	0.89	82	6.6	140	2.1	2.9	0.19	280
54	M3BP 225 SMB	3555	93.7	0.89	86	6.4	145	2.1	2.4	0.26	335
65	HO M3BP 225 SMC	3550	94.2	0.89	103	6.1	174	2.0	2.6	0.29	355
65	M3BP 250 SMA	3555	94.3	0.91	101	6.6	175	1.6	2.7	0.49	420
86	HO M3BP 250 SMB	3565	95.0	0.90	134	6.6	231	1.7	2.6	0.57	465
90	M2BA 280 SMA	3570	94.2	0.89	139	6.6	241	1.5	2.5	0.8	590
105	M2BA 280 SMB	3568	94.6	0.90	163	6.3	281	1.6	2.4	0.9	630
125	HO M2BA 280 SMC	3572	95.2	0.91	190	7.7	334	2.0	2.8	1.15	690
125	M3BP 315 SMA	3580	94.5	0.88	198	7.3	333	1.6	2.7	1.2	880
155	M3BP 315 SMB	3578	95.0	0.89	240	6.8	414	1.8	2.6	1.4	940
185	M3BP 315 SMC	3578	95.5	0.90	282	7.1	494	1.9	2.6	1.7	1025
230	M3BP 315 MLA	3576	95.9	0.90	355	7.0	614	2.1	2.7	2.1	1190
285	M2BA 355 S	3577	95.8	0.92	425	6.2	760	1.2	2.8	3.8	1550
360	M2BA 355 SMA	3573	96.0	0.92	535	6.8	962	1.1	3.0	4.8	1750
450	M2BA 355 MLA	3578	96.3	0.92	665	7.2	1201	1.5	3.3	6	2150
450	M2BA 400 M	3578	96.3	0.92	665	7.2	1201	1.5	3.3	6	2200
500	M2BA 400 MA	3575	96.0	0.92	745	7.2	1335	1.1	2.9	6	2200
500	M2BA 355 MLC	3575	96.0	0.92	745	7.2	1335	1.1	2.9	6	2150
1)	M2BA 400 LKA									7.5	2850
1)	M2BA 400 LKB									8.5	2900

# Technical data

## Marine motors with cast iron frame

IP 55 - IC 411 - Temperature rise 90 K

Output kW	Motor type	Product code	Speed r/min	Efficiency %	Power factor cos φ	Current		Torque			
						I <sub>N</sub> A	I <sub>s</sub> A	T <sub>N</sub> Nm	T <sub>s</sub> Nm	T <sub>max</sub> Nm	
<b>1500 r/min = 4 poles</b>						<b>380 V 50 Hz</b>					
0.3	M2BA 71 M4 A	3GBA 072 310-••C	1390	66.0	0.74	0.9	3.5	2.1	2.0	2.3	
0.4	M2BA 71 M4 B	3GBA 072 320-••C	1380	68.0	0.74	1.2	3.7	2.8	2.1	2.3	
0.6	M2BA 80 M4 A	3GBA 082 310-••C	1420	75.0	0.77	1.6	4.7	4	2.5	2.2	
0.8	M2BA 80 M4 B	3GBA 082 320-••C	1410	76.0	0.77	2.1	4.8	5.4	2.5	2.3	
1.2	M2BA 90 S4 A	3GBA 092 110-••C	1410	78.5	0.77	3	4.8	8.1	2.2	2.3	
1.6	M2BA 90 L4 A	3GBA 092 510-••C	1410	80.5	0.78	3.9	4.9	10.8	2.4	2.5	
2.3	M2BA 100 L4 A	3GBA 102 510-••C	1425	82.5	0.84	5	5.6	15.4	2.6	2.8	
3.2	M2BA 100 L4 B	3GBA 102 520-••C	1415	84.5	0.84	6.8	6.2	21.6	3.0	3.1	
4.2	M2BA 112 M4 A	3GBA 112 310-••C	1435	85.5	0.84	8.9	6.7	28	2.8	3.2	
5.8	M2BA 132 S4 A	3GBA 132 110-••C	1430	87.0	0.84	12.1	6.6	38.5	2.4	3.0	
8	M2BA 132 M4 A	3GBA 132 310-••C	1430	88.5	0.86	16	6.9	53	2.7	3.1	
11	M3BP 160 M	3GBP 162 101-••A	1450	88.4	0.83	22.5	5.6	76	2.1	2.3	
15	M3BP 160 L	3GBP 162 102-••A	1445	91.0	0.84	30	6.5	102	2.9	2.8	
17.5	HO M3BP 160 LB	3GBP 162 103-••A	1450	90.7	0.84	35	7.5	115	3.1	3.0	
18.5	M3BP 180 M	3GBP 182 101-••A	1465	91.6	0.85	36	6.0	124	2.8	2.4	
22	M3BP 180 L	3GBP 182 102-••A	1465	91.4	0.84	43	6.2	147	2.6	2.2	
28	HO M3BP 180 LB	3GBP 182 103-••A	1465	92.9	0.85	55	7.9	183	3.5	2.7	
30	M3BP 200 MLB	3GBP 202 001-••A	1470	93.1	0.85	58	7.4	195	3.8	2.9	
37	HO M3BP 200 MLB	3GBP 202 002-••A	1475	93.3	0.85	71	7.1	236	3.2	2.9	
37	M3BP 225 SMA	3GBP 222 001-••A	1475	93.4	0.84	72	5.7	246	2.2	2.2	
45	M3BP 225 SMB	3GBP 222 002-••A	1475	94.0	0.85	86	5.7	310	2.4	2.3	
55	HO M3BP 225 SMC	3GBP 222 003-••A	1475	94.5	0.84	105	6.4	369	2.8	2.5	
55	M3BP 250 SMA	3GBP 252 001-••A	1475	94.3	0.86	103	6.6	369	2.1	2.5	
75	HO M3BP 250 SMB	3GBP 252 002-••A	1475	94.5	0.87	139	6.1	499	2.2	2.7	
75	M2BA 280 SMA	3GBA 282 210-••A	1481	94.8	0.87	140	6.5	440	2.0	2.5	
90	M2BA 280 SMB	3GBA 282 220-••A	1481	95.1	0.88	165	6.7	580	2.1	2.4	
110	HO M2BA 280 SMC	3GBA 282 230-••A	1482	95.5	0.88	201	7.1	709	2.5	2.7	
110	M3BP 315 SMA	3GBP 312 210-••G	1486	95.5	0.87	202	6.5	707	1.8	2.3	
132	M3BP 315 SMB	3GBP 312 220-••G	1486	95.7	0.87	242	6.4	849	2.0	2.4	
160	M3BP 315 SMC	3GBP 312 230-••G	1485	95.9	0.86	296	6.6	1029	2.1	2.6	
200	M3BP 315 MLA	3GBP 312 410-••G	1484	96.1	0.87	366	6.6	1286	2.2	2.6	
250	M2BA 355 S	3GBA 352 100-••A	1486	96.4	0.88	450	6.4	1607	2.0	2.4	
315	M2BA 355 SMA	3GBA 352 210-••A	1487	96.7	0.88	565	6.9	2023	2.2	2.6	
355	M2BA 355 SMB	3GBA 352 220-••A	1485	96.7	0.88	635	6.2	2283	2.0	2.3	
400	M2BA 355 MLA	3GBA 352 410-••A	1488	96.8	0.88	710	6.3	2567	1.5	2.6	
400	M2BA 400 M	3GBA 402 300-••A	1488	96.8	0.88	710	6.3	2567	1.5	2.6	
450	M2BA 400 MA	3GBA 402 310-••A	1488	96.8	0.88	805	6.8	2888	1.3	2.7	
450	M2BA 355 MLB	3GBA 352 420-••A	1488	96.8	0.88	805	6.8	2888	1.3	2.7	
500	M2BA 400 MB	3GBA 402 320-••A	1488	96.8	0.89	880	7.0	3209	1.2	2.7	
500	M2BA 355 MLC	3GBA 352 430-••A	1488	96.8	0.89	880	7.0	3209	1.2	2.7	
560	M2BA 400 LKA	3GBA 402 510-••A	1487	96.8	0.91	965	6.0	3596	1.0	2.4	
630	M2BA 400 LKB	3GBA 402 520-••A	1488	96.8	0.88	1125	6.0	4043	1.0	2.5	

HO = High output design (Cenelec +1)

The two bullets indicate a 2-letter product code supplement for choice of mounting arrangement, and voltage and frequency; see ordering information.

Output kW	Motor type	Speed r/min	Efficiency %	Power factor cos φ	Current		Torque			Moment of inertia J = 1/4 GD <sup>2</sup> kgm <sup>2</sup>	Weight kg
					I <sub>N</sub> A	I <sub>s</sub> A	T <sub>N</sub> Nm	T <sub>s</sub> Nm	T <sub>max</sub> Nm		
<b>1800 r/min = 4 poles</b>		<b>440 V 60 Hz</b>									
0.3	M2BA 71 M4 A	1690	66.0	0.75	0.8	3.5	1.7	2.0	2.3	0.0006	11
0.5	M2BA 71 M4 B	1680	68.0	0.75	1.3	3.7	2.8	2.1	2.3	0.00077	11
0.7	M2BA 80 M4 A	1720	75.0	0.78	1.6	4.7	3.9	2.5	2.2	0.0018	17
0.9	M2BA 80 M4 B	1710	76.0	0.78	2	4.8	5	2.5	2.3	0.0021	18
1.3	M2BA 90 S4 A	1710	78.5	0.78	2.8	4.8	7.3	2.2	2.3	0.0029	25
1.8	M2BA 90 L4 A	1710	80.5	0.79	3.7	4.9	10.1	2.4	2.5	0.0037	26
2.7	M2BA 100 L4 A	1725	82.5	0.85	5.1	5.6	14.9	2.6	2.8	0.0075	34
3.7	M2BA 100 L4 B	1715	84.5	0.85	6.8	6.2	20.6	3.0	3.1	0.0098	35
4.9	M2BA 112 M4 A	1735	85.5	0.85	8.8	6.7	27	2.8	3.2	0.014	44
6.7	M2BA 132 S4 A	1730	87.0	0.85	11.9	6.6	37	2.4	3.0	0.031	65
9.1	M2BA 132 M4 A	1730	88.5	0.87	15.5	6.9	50	2.7	3.1	0.04	79
13	M3BP 160 M	1740	88.4	0.85	23.5	5.6	71	1.9	2.3	0.067	115
18	M3BP 160 L	1750	91.0	0.85	30.5	6.5	98	2.6	2.7	0.091	127
20	HO M3BP 160 LB	1750	90.7	0.84	35	7.5	109	2.8	3.0	0.102	135
22	M3BP 180 M	1765	91.6	0.85	37.5	6.0	119	2.5	2.3	0.161	175
26	M3BP 180 L	1760	91.4	0.85	44	6.2	144	2.3	2.1	0.191	185
32	HO M3BP 180 LB	1765	91.8	0.85	55	7.9	176	3.1	2.6	0.225	203
38	M3BP 200 MLB	1765	93.4	0.86	63	6.9	206	3.2	2.5	0.34	205
42	HO M3BP 200 MLB	1775	93.3	0.85	71	7.1	226	2.9	2.8	0.34	275
44	M3BP 225 SMA	1775	93.4	0.84	74	5.7	237	2.0	2.2	0.37	310
55	M3BP 225 SMB	1775	94.0	0.85	92	6.7	296	2.2	2.3	0.42	310
65	HO M3BP 225 SMC	1775	94.5	0.84	109	6.4	350	2.5	2.5	0.49	355
65	M3BP 250 SMA	1775	94.3	0.86	107	6.6	350	1.9	2.5	0.72	420
88	HO M3BP 250 SMB	1775	94.5	0.87	142	6.1	474	2.0	2.7	0.88	465
88	M3BP 280 SMA	1780	94.6	0.87	141	6.6	472	1.9	2.5	1.25	590
105	M2BA 280 SMB	1780	94.9	0.88	165	6.9	563	2.0	2.4	1.5	630
125	HO M2BA 280 SMC	1782	95.4	0.88	196	7.5	670	2.4	2.7	1.85	690
125	M3BP 315 SMA	1786	95.3	0.87	199	6.7	668	1.7	2.3	2.3	900
150	M3BP 315 SMB	1785	95.5	0.87	236	6.7	802	2.0	2.5	2.6	960
185	M3BP 315 SMC	1785	95.8	0.86	295	6.8	990	2.0	2.6	2.9	1000
230	M3BP 315 MLA	1784	96.0	0.87	362	6.8	1231	2.2	2.6	3.5	1160
285	M2BA 355 S	1785	96.1	0.88	445	6.5	1524	1.9	2.4	6.5	1550
360	M2BA 355 SMA	1787	96.4	0.88	560	7.1	1923	2.1	2.6	8.2	1800
400	M2BA 355 SMB	1784	96.4	0.88	620	6.4	2141	1.9	2.3	8.2	1800
450	M2BA 355 MLA	1786	96.6	0.88	695	6.5	2406	1.5	2.6	10	2100
450	M2BA 400 M	1786	96.6	0.88	695	6.5	2406	1.5	2.6	10	2150
500	M2BA 400 MA	1787	96.6	0.88	770	7.1	2672	1.2	2.7	10	2150
500	M2BA 355 MLB	1787	96.6	0.88	770	7.1	2672	1.2	2.7	10	2100
560	M2BA 400 MB	1788	96.6	0.89	855	7.2	2991	1.2	2.7	10.5	2150
560	M2BA 355 MLC	1788	96.6	0.89	855	7.2	2991	1.2	2.7	10.5	2100
630	M2BA 400 LKA	1787	96.7	0.9	940	5.9	3366	0.9	2.4	14	3050
710	M2BA 400 LKB	1788	96.7	0.88	1095	6.1	3792	0.9	2.6	15	3150

# Technical data

## Marine motors with cast iron frame

IP 55 - IC 411 - Temperature rise 90 K

Output kW	Motor type	Product code	Speed r/min	Effi- ciency %	Power factor cos φ	Current		Torque			
						I <sub>N</sub> A	I <sub>s</sub> A	T <sub>N</sub> Nm	T <sub>s</sub> Nm	T <sub>max</sub> Nm	
<b>1000 r/min = 6 poles</b>			<b>380 V 50 Hz</b>								
0.2	M2BA 71 M6 A	3GBA 073 310-••C	850	49.0	0.60	1.0	3.0	2.2	1.9	2.0	
0.3	M2BA 71 M6 B	3GBA 073 320-••C	860	53.0	0.61	1.4	3.2	3.3	2.2	2.4	
0.4	M2BA 80 M6 A	3GBA 083 310-••C	925	68.0	0.67	1.3	3.2	4.1	1.7	2.2	
0.6	M2BA 80 M6 B	3GBA 083 320-••C	930	70.0	0.67	1.9	3.6	6.2	1.7	2.2	
0.8	M2BA 90 S6 A	3GBA 093 110-••C	935	74.0	0.71	2.3	4.3	8.2	2.1	2.5	
1.2	M2BA 90 L6 A	3GBA 093 510-••C	920	75.0	0.75	3.2	4.1	12.5	2.0	2.3	
1.6	M2BA 100 L6 A	3GBA 103 510-••C	950	79.0	0.72	4.3	5.0	16.1	2.3	2.7	
2.3	M2BA 112 M6 A	3GBA 113 310-••C	950	83.0	0.76	5.5	5.7	23.1	2.2	2.7	
3.2	M2BA 132 S6 A	3GBA 133 110-••C	955	84.5	0.79	7.3	6.2	32	2.2	3.0	
4.2	M2BA 132 M6 A	3GBA 133 310-••C	955	85.0	0.77	9.7	6.5	42	2.6	3.3	
5.8	M2BA 132 M6 B	3GBA 133 320-••C	955	87.0	0.80	12.7	6.9	58	2.6	3.1	
7.5	M3BP 160 M	3GBP 163 101-••A	960	88.5	0.80	16.1	6.2	84	1.8	2.5	
11	M3BP 160 L	3GBP 163 102-••A	960	89.4	0.80	23.5	7.0	113	2.1	2.9	
13.5	HO M3BP 160 LB	3GBP 163 103-••A	965	89.7	0.77	30	8.3	134	3.2	3.7	
15	M3BP 180 L	3GBP 183 101-••A	970	90.5	0.79	32	6.4	153	1.8	2.7	
16.5	HO M3BP 180 LB	3GBP 183 102-••A	965	90.6	0.80	35	6.2	163	1.7	2.6	
18.5	M3BP 200 MLA	3GBP 203 001-••A	980	90.8	0.81	38	6.1	185	2.2	2.4	
22	M3BP 200 MLB	3GBP 203 002-••A	980	91.6	0.81	45	6.2	225	2.3	2.4	
30	HO M3BP 200 MLC	3GBP 203 003-••A	980	91.5	0.83	57	7.0	292	3.0	2.7	
30	M3BP 225 SMB	3GBP 223 001-••A	985	92.6	0.83	59	6.0	291	2.3	2.4	
37	HO M3BP 225 SMC	3GBP 223 002-••A	980	93.0	0.83	72	6.8	371	2.8	2.7	
37	M3BP 250 SMA	3GBP 253 001-••A	985	93.5	0.84	72	6.6	359	2.5	2.5	
45	HO M3BP 250 SMB	3GBP 253 002-••A	985	93.8	0.86	85	6.7	436	2.5	2.5	
45	M2BA 280 SMA	3GBA 283 210-••A	988	94.2	0.85	87	6.4	435	2.4	2.4	
55	M2BA 280 SMB	3GBA 283 220-••A	988	94.4	0.85	105	6.4	532	2.5	2.4	
75	HO M2BA 280 SMC	3GBA 283 230-••A	988	94.9	0.85	143	6.8	725	2.5	2.4	
75	M3BP 315 SMA	3GBP 313 210-••G	991	94.9	0.84	145	6.8	723	2.1	2.5	
90	M3BP 315 SMB	3GBP 313 220-••G	991	95.4	0.85	169	6.8	867	2.2	2.5	
110	M3BP 315 SMC	3GBP 313 230-••G	990	95.5	0.84	211	6.7	1061	2.2	2.6	
132	M3BP 315 MLA	3GBP 313 410-••G	990	95.7	0.84	250	6.7	1273	2.3	2.7	
160	M2BA 355 S	3GBA 353 100-••A	991	95.8	0.86	295	6.2	1542	1.6	2.4	
200	M2BA 355 SMA	3GBA 353 210-••A	991	95.8	0.86	370	6.5	1927	1.8	2.5	
250	M2BA 400 M	3GBA 403 300-••A	991	96.0	0.86	470	6.9	2409	2.0	2.6	
250	M2BA 355 SMB	3GBA 353 220-••A	991	96.0	0.86	470	6.9	2409	2.0	2.6	
315	M2BA 355 MLA	3GBA 353 410-••A	990	96.2	0.85	590	6.6	3039	1.8	2.7	
315	M2BA 400 MA	3GBA 403 310-••A	990	96.2	0.85	590	6.6	3039	1.8	2.7	
355	M2BA 355 MLC	3GBA 353 430-••A	990	96.3	0.86	655	6.9	3424	1.3	2.7	
355	M2BA 400 MB	3GBA 403 320-••A	990	96.3	0.86	655	6.9	3424	1.3	2.7	
400	M2BA 400 LKA	3GBA 403 510-••A	991	96.3	0.86	730	5.8	3854	1.1	2.5	
450	M2BA 400 LKB	3GBA 403 520-••A	992	96.5	0.86	825	6.1	4332	1.1	2.6	
500	M2BA 400 LKC	3GBA 403 530-••A	991	96.5	0.86	920	6.1	4818	1.1	2.6	

HO = High output design (Cenelec +1)

The two bullets indicate a 2-letter product code supplement for choice of mounting arrangement, and voltage and frequency; see ordering information.



Output kW	Motor type	Speed r/min	Efficiency %	Power factor cos φ	Current		Torque			Moment of inertia J = 1/4GD <sup>2</sup> kgm <sup>2</sup>	Weight kg
					I <sub>N</sub> A	I <sub>s</sub> I <sub>N</sub>	T <sub>N</sub> Nm	T <sub>s</sub> T <sub>N</sub>	T <sub>max</sub> T <sub>N</sub>		
<b>1200 r/min = 6 poles</b>		<b>440 V 60 Hz</b>									
0.2	M2BA 71 M6 A	1050	49.0	0.61	0.9	3.0	1.8	1.9	2.0	0.0006	11
0.3	M2BA 71 M6 B	1060	53.0	0.62	1.2	3.2	2.7	2.2	2.4	0.00082	11
0.5	M2BA 80 M6 A	1125	68.0	0.68	1.4	3.2	4.2	1.7	2.2	0.0019	17
0.7	M2BA 80 M6 B	1130	70.0	0.68	1.9	3.6	5.9	1.7	2.2	0.0024	18
0.9	M2BA 90 S6 A	1135	74.0	0.72	2.2	4.3	7.6	2.1	2.5	0.0039	21
1.3	M2BA 90 L6 A	1120	75.0	0.76	3	4.1	11.1	2.0	2.3	0.0049	24
1.8	M2BA 100 L6 A	1150	79.0	0.73	4.1	5.0	14.9	2.3	2.7	0.011	35
2.7	M2BA 112 M6 A	1150	83.0	0.77	5.5	5.7	22.5	2.2	2.7	0.017	44
3.7	M2BA 132 S6 A	1155	84.5	0.80	7.2	6.2	30.5	2.2	3.0	0.038	71
4.9	M2BA 132 M6 A	1155	85.0	0.78	9.7	6.5	40	2.6	3.3	0.049	78
6.7	M2BA 132 M6 B	1155	87.0	0.81	12.5	6.9	55	2.6	3.1	0.065	80
9.8	M3BP 160 M	1165	88.5	0.80	18.5	6.2	80	1.6	2.5	0.089	115
13	M3BP 160 L	1170	89.4	0.79	25	7.0	106	1.9	2.9	0.307	135
16	HO M3BP 160 LB	1165	89.7	0.77	30	8.3	127	2.9	3.7	0.127	148
18	M3BP 180 L	1165	90.5	0.79	33	6.4	143	1.6	2.7	0.217	177
19	HO M3BP 180 LB	1165	90.6	0.80	35	6.2	156	1.5	2.6	0.237	185
22	M3BP 200 MLA	1180	90.8	0.82	39	6.1	122	2.0	2.3	0.37	245
26	M3BP 200 MLB	1175	91.6	0.83	47	6.2	210	2.1	2.4	0.43	260
34	HO M3BP 200 MLC	1180	91.5	0.83	57	7.0	275	2.7	2.7	0.49	275
35	M3BP 225 SMB	1185	92.6	0.83	61	6.0	283	2.0	2.3	0.64	320
44	HO M3BP 225 SMC	1180	93.0	0.83	74	6.8	356	2.5	2.6	0.75	345
43	M3BP 250 SMA	1185	93.5	0.84	73	6.6	347	2.2	2.4	1.16	415
52	HO M3BP 250 SMB	1185	93.8	0.86	85	6.7	419	2.2	2.4	1.49	460
55	M2BA 280 SMA	1186	94.1	0.84	92	6.2	443	2.3	2.3	1.85	570
63	M2BA 280 SMB	1187	94.3	0.84	104	6.6	507	2.4	2.4	2.2	610
86	HO M2BA 280 SMC	1187	94.9	0.85	142	7.1	692	2.4	2.4	2.85	690
86	M3BP 315 SMA	1191	94.9	0.84	142	7.1	690	2.1	2.5	3.2	830
105	M3BP 315 SMB	1191	95.3	0.85	171	6.9	842	2.1	2.5	4.1	930
125	M3BP 315 SMC	1190	95.6	0.84	205	7.1	1003	2.2	2.7	4.9	1000
150	M3BP 315 MLA	1190	95.7	0.84	246	7.2	1204	2.4	2.7	5.8	1150
195	M2BA 355 S	1190	95.5	0.86	310	5.9	1564	1.4	2.2	10.4	1550
230	M2BA 355 SMA	1191	95.5	0.86	370	6.5	1844	1.7	2.4	12.5	1800
300	M2BA 400 M	1191	95.7	0.85	485	6.8	2405	1.8	2.4	12.5	2000
300	M2BA 355 SMB	1191	95.7	0.85	485	6.8	2405	1.8	2.4	12.5	1800
360	M2BA 355 MLA	1189	96.0	0.85	580	6.8	2891	1.7	2.7	14.6	2100
360	M2BA 400 MA	1189	96.0	0.85	580	6.8	2891	1.7	2.7	14.6	2150
400	M2BA 355 MLC	1190	96.1	0.86	635	7.1	3210	1.2	2.7	15.8	2100
400	M2BA 400 MB	1190	96.1	0.86	635	7.1	3210	1.2	2.7	15.8	2150
450	M2BA 400 LKA	1191	96.3	0.86	710	5.9	3608	1	2.5	16.5	2800
510	M2BA 400 LKB	1192	96.5	0.86	810	6.2	4085	1.1	2.6	19	3050
560	M2BA 400 LKC	1192	96.5	0.86	875	6.2	4486	1.1	2.6	19	3050

# Technical data

## Marine motors with cast iron frame

IP 55 - IC 411 - Temperature rise 90 K

Output kW	Motor type	Product code	Speed r/min	Effi- ciency %	Power factor cos φ	Current		Torque					
						I <sub>N</sub> A	I <sub>s</sub> A	T <sub>N</sub> Nm	T <sub>s</sub> Nm	T <sub>max</sub> Nm			
<b>750 r/min = 8 poles</b>			<b>380 V 50 Hz</b>										
4	M3BP	160 MA	3GBP	164 101-••A	710	81.1	0.71	10.2	4.0	61	1.3	1.9	
5.5	M3BP	160 M	3GBP	164 102-••A	705	83.2	0.72	13.8	4.7	74	1.6	2.3	
7.5	M3BP	160 L	3GBP	164 103-••A	710	85.5	0.72	18.6	5.4	102	2.1	2.4	
11	M3BP	180 L	3GBP	184 101-••A	715	87.5	0.77	24.5	4.5	154	1.5	2.0	
13.5	HO	M3BP	180 LB	3GBP	184 102-••A	715	86.8	0.8	30	4.6	180	1.5	2.1
15	M3BP	200 MLA	3GBP	204 001-••A	735	91.0	0.83	30	6.4	208	1.6	2.7	
18.5	HO	M3BP	200 MLB	3GBP	204 002-••A	735	91.2	0.83	37	6.2	240	1.5	2.5
18.5	M3BP	225 SMA	3GBP	224 001-••A	730	91.0	0.79	39	5.6	242	1.7	2.4	
22	M3BP	225 SMB	3GBP	224 002-••A	730	91.4	0.81	45	5.7	288	1.7	2.4	
30	HO	M3BP	225 SMC	3GBP	224 003-••A	730	91.7	0.80	62	6.6	393	1.9	2.9
30	M3BP	250 SMA	3GBP	254 001-••A	735	92.6	0.81	61	6.3	390	1.7	2.6	
37	HO	M3BP	250 SMB	3GBP	254 002-••A	735	92.5	0.82	74	6.6	481	1.8	2.6
37	M2BA	280 SMA	3GBA	284 210-••A	740	93.0	0.80	75	6.3	477	1.4	2.4	
45	M2BA	280 SMB	3GBA	284 220-••A	740	93.5	0.80	92	7.1	581	1.6	2.6	
55	HO	M2BA	280 SMC	3GBA	284 230-••A	740	93.9	0.81	110	6.7	710	1.6	2.5
55	M3BP	315 SMA	3GBP	314 210-••G	741	93.9	0.83	108	6.5	709	1.4	2.4	
75	M3BP	315 SMB	3GBP	314 220-••G	740	94.2	0.83	147	6.6	969	1.5	2.4	
90	M3BP	315 SMC	3GBP	314 230-••G	740	94.6	0.84	173	6.8	1163	1.6	2.4	
110	M3BP	315 MLA	3GBP	314 410-••G	739	94.9	0.84	210	6.7	1421	1.6	2.4	
132	M2BA	355 S	3GBA	354 100-••A	741	94.8	0.81	260	5.3	1701	1.4	2.1	
160	M2BA	355 SMA	3GBA	354 210-••A	741	95.1	0.81	315	5.6	2062	1.5	2.2	
200	M2BA	400 M	3GBA	404 300-••A	742	95.5	0.79	410	5.9	2574	1.6	2.4	
200	M2BA	355 MLA	3GBA	354 410-••A	742	95.5	0.79	410	5.9	2574	1.6	2.4	
250	M2BA	355 MLC	3GBA	354 430-••A	743	95.7	0.82	485	6.0	3213	1.3	2.7	
250	M2BA	400 MA	3GBA	404 310-••A	743	95.7	0.82	485	6.0	3213	1.3	2.7	
315	M2BA	400 LKA	3GBA	404 510-••A	743	96.0	0.81	615	5.8	4048	1.3	2.4	
355	M2BA	400 LKB	3GBA	404 520-••A	743	96.2	0.81	690	6.1	4563	1.3	2.4	

HO = High output design (Cenelec +1)

The two bullets indicate a 2-letter product code supplement for choice of mounting arrangement, and voltage and frequency; see ordering information.

Output kW	Motor type	Speed r/min	Efficiency %	Power factor cos φ	Current		Torque			Moment of inertia J = 1/4GD <sup>2</sup> kgm <sup>2</sup>	Weight kg
					I <sub>N</sub> A	I <sub>s</sub> I <sub>N</sub>	T <sub>N</sub> Nm	T <sub>s</sub> T <sub>N</sub>	T <sub>max</sub> T <sub>N</sub>		
<b>900 r/min = 8 poles 440 V 60 Hz</b>											
5.2	M3BP 160 MA	850	81.0	0.75	11.5	4.0	58	1.2	1.9	0.072	100
6.3	M3BP 160 M	860	83.2	0.72	14.5	4.7	70	1.5	2.3	0.091	113
8.6	M3BP 160 L	855	85.5	0.73	18.5	5.4	96	1.9	2.4	0.131	126
14	M3BP 180 L	865	87.5	0.80	25.5	4.5	149	1.3	1.9	0.224	177
16	HO M3BP 180 LB	865	86.8	0.80	30	4.6	171	1.4	2.1	0.24	185
18	M3BP 200 MLA	885	91.0	0.84	32	6.4	194	1.5	2.7	0.45	250
21	HO M3BP 200 MLB	885	91.2	0.83	37	6.2	227	1.4	2.5	0.54	275
21	M3BP 225 SMA	880	91.0	0.79	39	5.6	228	1.5	2.4	0.61	305
25	M3BP 225 SMB	880	91.4	0.81	45	5.7	271	1.7	2.4	0.68	320
34	HO M3BP 225 SMC	880	91.7	0.80	62	6.6	369	1.7	2.9	0.8	345
34	M3BP 250 SMA	885	92.6	0.81	61	6.3	367	1.5	2.6	1.25	415
42	HO M3BP 250 SMB	885	92.5	0.82	74	6.6	453	1.6	2.6	1.52	460
43	M2BA 280 SMA	890	93.2	0.81	75	6.2	461	1.3	2.4	1.85	570
55	M2BA 280 SMB	889	93.3	0.82	95	6.3	591	1.4	2.4	2.2	610
65	HO M2BA 280 SMC	889	93.9	0.82	110	6.6	698	1.4	2.4	2.85	690
63	M3BP 315 SMA	890	94.1	0.83	107	6.5	676	1.4	2.4	3.2	830
85	M3BP 315 SMB	890	94.5	0.84	141	6.6	912	1.4	2.4	4.1	930
105	M3BP 315 SMC	890	94.8	0.84	172	6.7	1127	1.5	2.3	4.9	1000
125	M3BP 315 MLA	889	95.1	0.84	205	6.8	1343	1.5	2.4	5.8	1150
150	M2BA 355 S	890	94.6	0.81	257	5.4	1609	1.3	2.1	10.4	1550
180	M2BA 355 SMA	891	95.0	0.81	310	5.8	1929	1.4	2.2	12.5	1800
230	M2BA 400 M	893	95.3	0.79	405	5.9	2459	1.5	2.4	14.6	2150
230	M2BA 355 MLA	893	95.3	0.79	405	5.9	2459	1.5	2.4	14.6	2100
285	M2BA 355 MLC	892	95.6	0.82	480	6.0	3051	1.2	2.7	15.8	2100
285	M2BA 400 MA	892	95.6	0.82	480	6.0	3051	1.2	2.7	15.8	2150
360	M2BA 400 LKA	893	96.0	0.82	605	5.8	3849	1.2	2.4	16.5	2800
400	M2BA 400 LKB	893	96.2	0.81	680	6.2	4277	1.3	2.5	19	3050

# Technical data

## Marine motors with cast iron frame, two speed

IP 55 - IC 411 - Temperature rise 90 K

Output kW	Motor type	Product code	Speed r/min	Efficiency %	Power factor cos φ	Current		Torque		
						$I_N$ A	$I_s$ $I_N$	$T_N$ Nm	$T_s$ $T_N$	$T_{max}$ $T_N$
<b>3000/1500 r/min = 2/4 poles</b>			<b>380 V 50 Hz</b>			<b>Fan drive, two separate windings</b>				
11.4/1.7	M3BP 160 M	3GBP 168352-**A	2940/1470	88.8/77.3	0.90/0.75	22/4.5	8.5/5.8	37/37	2.3/2.0	3.2/2.4
15.3/2.2	M3BP 160 L	3GBP 168353-**A	2940/1480	89.5/78.4	0.91/0.66	28/6.5	8.1/7.2	50/50	2.3/3.0	3.0/3.4
17.5/2.5	M3BP 180 M	3GBP 188357-**A	2935/1465	88.6/76.5	0.91/0.78	33/6.5	6.7/5.5	57/57	2.0/1.9	2.4/1.9
22/3.2	M3BP 180 L	3GBP 188358-**A	2940/1465	90.5/77.1	0.91/0.80	41/8	8.1/4.5	71/71	2.7/1.8	3.0/1.8
26/3.6	M3BP 200 MLA	3GBP 208210-**A	2945/1480	91.5/85.0	0.89/0.72	49/9.2	8.3/7.3	84/84	2.3/2.7	2.9/2.8
33/4.8	M3BP 200 MLB	3GBP 208211-**A	2945/1480	92.5/86.5	0.91/0.74	61/11.9	8.0/7.0	107/107	2.3/2.7	2.7/2.7
38/5.3	M3BP 225 SMB	3GBP 228207-**A	2950/1475	92.5/86.5	0.90/0.78	70/12.1	7.3/5.9	123/123	2.3/2.8	2.4/2.1
44/6.2	M3BP 225 SMC	3GBP 228208-**A	2955/1480	93.0/87.5	0.91/0.78	80/14	7.5/6.2	142/142	2.5/2.9	2.5/2.1
62/8.8	M3BP 250 SMB	3GBP 258204-**A	2965/1485	94.0/89.5	0.90/0.76	111/20	9.5/7.3	200/200	2.3/2.6	3.2/2.3
84/12	M2BA 280 SMB	3GBA 288221-**A	2977/1490	94.5/91.0	0.89/0.76	153/27	7.2/6.6	269/77	1.9/2.7	2.7/2.6
100/15	M2BA 280 SMC	3GBA 288231-**A	2980/1490	95.0/91.4	0.89/0.78	182/32	9.5/6.9	320/96	2.6/2.8	3.6/2.5
115/17	M2BA 315 SMB	3GBA 318221-**A	2975/1490	95.0/91.5	0.89/0.77	207/37	6.5/6.4	369/109	1.7/2.8	2.6/3.0
135/20	M2BA 315 SMC	3GBA 318231-**A	2974/1487	95.2/91.7	0.90/0.78	240/42.5	6.5/5.7	433/128	1.8/2.3	2.5/2.6
170/24	M2BA 315 MLA	3GBA 318411-**A	2980/1488	95.9/92.5	0.90/0.79	300/50	7.5/5.6	545/154	2.3/2.5	2.9/2.6
200/25	M2BA 355 S	3GBA 358101-**A	2975/1490	95.0/91.0	0.90/0.79	355/55	6.0/6.2	642/160	1.2/1.3	2.7/2.9
250/32	M2BA 355 SMA	3GBA 358211-**A	2970/1490	95.0/92.0	0.92/0.79	435/68	6.0/6.3	803/205	1.1/1.4	2.8/3.5
315/40	M2BA 355 MLA	3GBA 358411-**A	2984/1492	95.8/93.4	0.90/0.75	550/85	8.3/7.6	1008/256	1.7/2.0	3.5/3.6
315/40	M2BA 400 M	3GBA 408301-**A	2984/1492	95.8/93.4	0.90/0.75	550/85	8.3/7.6	1008/256	1.7/2.0	3.5/3.6
	M2BA 400 LKA	3GBA 408511-**A								
<b>3000/1500 r/min = 2-4 poles</b>			<b>380 V 50 Hz</b>			<b>Fan drive, Dahlander-connection</b>				
8.8/1.8	M3BP 160 MA	3GBP 168301-**A	2915/1465	84.0/81.6	0.90/0.71	18/5	5.8/5.5	29/29	1.4/2.0	2.2/2.3
14/2.8	M3BP 160 M	3GBP 168302-**A	2920/1465	86.4/84.1	0.92/0.74	27/7	6.2/5.6	46/46	1.6/2.1	2.2/2.4
17/4	M3BP 160 L	3GBP 168303-**A	2930/1465	88.6/86.4	0.91/0.74	32.5/9.5	7.5/5.7	55/55	2.1/2.2	2.8/2.5
18.9/4.1	M3BP 180 M	3GBP 188305-**A	2935/1470	88.9/87.1	0.92/0.76	35.5/9.5	6.9/5.5	62/62	2.0/2.1	2.5/2.3
22.8/4.6	M3BP 180 L	3GBP 188306-**A	2940/1470	89.8/88.1	0.92/0.75	42/10.5	7.5/5.9	74/74	2.1/2.2	2.6/2.5
28/7	M3BP 200 MLA	3GBP 208110-**A	2940/1465	90.0/89.0	0.89/0.85	53/15	7.3/6.4	91/91	2.1/2.1	2.6/2.3
34/8.8	M3BP 200 MLB	3GBP 208111-**A	2950/1475	91.5/91.0	0.89/0.85	63/18	7.7/6.4	110/110	2.1/2.1	2.7/2.4
37/9.7	M3BP 200 MLC	3GBP 208112-**A	2950/1470	92.5/91.0	0.89/0.77	70/21	7.9/5.7	120/120	2.3/2.1	3.1/2.5
40/11.4	M3BP 225 SMB	3GBP 228107-**A	2955/1475	93.0/91.5	0.92/0.82	71/23	7.5/5.5	129/129	2.0/2.1	2.6/2.2
48/13.2	M3BP 225 SMC	3GBP 228108-**A	2955/1475	93.5/92.5	0.91/0.82	86/27	7.5/5.5	155/155	2.1/2.0	2.7/2.3
66/22	M3BP 250 SMB	3GBP 258104-**A	2965/1475	94.5/93.0	0.92/0.82	116/44	9.1/5.6	213/213	2.4/2.1	3.2/2.3
90/30	M2BA 280 SMB	3GBA 288228-**A	2960/1480	93.2/93.0	0.92/0.85	159/58	6.6/5.2	290/194	1.3/1.5	2.7/1.9
100/31	M2BA 280 SMC	3GBA 288238-**A	2968/1478	93.4/93.0	0.94/0.85	173/60	7.9/4.9	322/200	1.7/1.6	2.9/1.8
115/32	M2BA 315 SMB	3GBA 318228-**A	2970/1484	94.8/94.3	0.89/0.76	207/68	6.6/5.2	370/206	1.3/1.6	2.6/2.5
155/38	M2BA 315 MLA	3GBA 318418-**A	2970/1484	95.3/94.8	0.89/0.77	280/80	7.2/5.5	498/244	1.7/1.8	2.7/2.5
190/45	M2BA 355 S	3GBA 358108-**A	2985/1490	95.0/94.0	0.85/0.75	360/98	7.5/5.5	607/288	1.6/1.5	2.4/2.1
200/50	M2BA 355 SMA	3GBA 358218-**A	2985/1490	95.0/94.5	0.85/0.77	375/105	7.0/6.0	639/320	1.8/1.8	2.6/2.4
	M2BA 355 MLA	3GBA 358418-**A								
	M2BA 400 M	3GBA 408308-**A								
	M2BA 400 LKA	3GBA 408518-**A								

1) On request.

The two bullets indicate a 2-letter product code supplement for choice of mounting arrangement, and voltage and frequency; see product catalogue for details.

Output kW	Motor type	Speed r/min	Efficiency %	Power factor cos φ	Current		Torque			Moment of inertia J = 1/4GD <sup>2</sup> kgm <sup>2</sup>	Weight kg
					$I_N$ A	$I_s$ $I_N$	$T_N$ Nm	$T_s$ $T_N$	$T_{max}$ $T_N$		
<b>3600/1800 r/min = 2/4 poles      440 V 60 Hz      Fan drive, two separate windings</b>											
13.1/2	M3BP 160 M	3540/1770	88.8/77.3	0.90/0.75	22/4.5	8.5/5.8	35/11	2.3/1.8	3.1/2.3	0.054	133
17.6/2.5	M3BP 160 L	3540/1780	89.5/78.4	0.91/0.66	28/6.5	8.1/7.2	48/13	2.1/2.7	2.9/3.4	0.057	140
20.1/2.9	M3BP 180 M	3535/1765	88.6/76.5	0.91/0.78	33/6.5	6.7/5.5	54/16	1.8/1.7	2.4/1.9	0.094	194
25.3/3.7	M3BP 180 L	3540/1765	90.5/77.1	0.91/0.80	41/8	8.1/4.5	68/20	2.4/1.6	2.9/1.8	0.108	200
30/4.2	M3BP 200 MLA	3545/1780	91.5/85.0	0.89/0.72	49/9.2	8.3/7.3	81/23	2.1/2.4	2.8/2.7	0.15	250
38/5.6	M3BP 200 MLB	3545/1780	92.5/86.5	0.91/0.74	61/11.9	8.0/7.0	102/30	2.1/2.4	2.6/2.6	0.19	270
44/6.1	M3BP 225 SMB	3550/1775	92.5/86.5	0.90/0.78	70/12.1	7.3/5.9	118/33	2.1/2.5	2.3/2.0	0.26	335
51/7.2	M3BP 225 SMC	3555/1780	93.0/87.5	0.91/0.78	80/14	7.5/6.2	137/39	2.2/2.6	2.4/2.0	0.29	355
72/10.2	M3BP 250 SMB	3565/1785	94.0/89.5	0.90/0.76	111/20	9.5/7.3	193/55	2.1/2.3	3.1/2.3	0.57	465
100/15	M2BA 280 SMB	3575/1790	94.2/90.5	0.89/0.78	157/28	7.0/7.1	267/80	1.7/1.7	2.6/2.5	0.9	630
115/18.5	M2BA 280 SMC	3580/1790	94.8/91.2	0.89/0.79	179/34	9.7/6.8	307/99	2.4/2.6	3.6/2.4	1.15	690
132/20	M2BA 315 SMB	3575/1790	94.8/91.3	0.89/0.77	205/36.5	6.5/6.4	353/107	2.5/2.5	2.6/3.0	1.4	920
155/23	M2BA 315 SMC	3574/1787	95.9/91.5	0.90/0.78	238/42	6.5/5.7	414/123	1.6/2.0	2.5/2.6	1.7	1010
195/28	M2BA 315 MLA	3580/1788	95.7/92.3	0.90/0.79	296/50	7.6/5.6	520/150	2.1/2.3	2.9/2.6	2.1	1170
230/29	M2BA 355 S	3575/1790	94.5/90.7	0.90/0.79	355/53	6.0/6.2	614/155	1.1/1.2	2.6/2.8	3.8	1550
285/37	M2BA 355 SMA	3570/1790	94.5/91.7	0.92/0.79	430/67	6.0/6.3	762/197	1.0/1.3	2.7/3.4	4.8	1750
360/46	M2BA 355 MLA	3584/1792	95.3/93.1	0.90/0.75	550/86	8.3/7.6	959/245	1.6/1.9	3.4/3.5	6	2150
360/46	M2BA 400 M	3584/1792	95.3/93.1	0.90/0.75	550/86	8.3/7.6	959/245	1.6/1.9	3.4/3.5	6	2200
	M2BA 400 LKA										
<b>3600/1800 r/min = 2-4 poles      440 V 60 Hz      Fan drive, Dahlander-connection</b>											
10.1/2.1	M3BP 160 MA	3515/1765	84.4/81.6	0.90/0.71	18/5	5.8/5.5	27/11	1.3/1.8	2.2/2.5	0.039	118
16.1/3.2	M3BP 160 M	3520/1765	86.4/84.1	0.92/0.74	27/7	6.2/5.6	44/17	1.4/1.9	2.2/2.4	0.054	133
19.6/4.6	M3BP 160 L	3530/1765	88.6/86.4	0.91/0.74	32.5/9.5	7.5/5.7	53/25	1.9/2.0	2.7/2.5	0.057	140
21.7/4.7	M3BP 180 M	3535/1770	88.9/87.1	0.92/0.76	35.5/9.5	6.9/5.5	59/25	1.8/1.9	2.5/2.3	0.094	194
26.2/5.3	M3BP 180 L	3540/1770	89.8/88.1	0.92/0.75	42/10.5	7.5/5.9	71/29	1.9/2.0	2.6/2.5	0.108	200
32/8.1	M3BP 200 MLA	3540/1765	90.0/89.0	0.89/0.85	53/15	7.3/6.4	86/44	1.9/1.9	2.6/2.3	0.29	255
39/10.2	M3BP 200 MLB	3550/1775	91.5/91.0	0.89/0.85	63/18	7.7/6.4	105/55	1.9/1.9	2.7/2.3	0.34	275
43/11.2	M3BP 200 MLC	3550/1770	92.5/91.0	0.89/0.77	69/21	7.9/5.7	116/60	2.0/1.9	3.0/2.5	0.19	280
46/13.2	M3BP 225 SMB	3555/1775	93.0/91.5	0.92/0.82	71/23	7.5/5.5	124/71	1.8/1.9	2.5/2.2	0.26	335
56/15.3	M3BP 225 SMC	3555/1775	93.5/92.5	0.91/0.82	86/27	7.6/5.5	148/82	1.9/1.8	2.7/2.2	0.29	355
76/25	M3BP 250 SMB	3565/1775	94.5/93.0	0.92/0.92	116/44	9.1/5.6	204/135	2.2/1.9	3.1/2.3	0.57	465
105/35	M2BA 280 SMB	3560/1780	92.9/93.4	0.92/0.85	160/58	6.5/5.2	282/188	1.2/1.4	2.7/1.9	1.5	630
115/36	M2BA 280 SMC	3568/1777	93.0/93.0	0.94/0.84	173/60	7.8/4.9	308/193	1.5/1.4	2.9/1.8	1.85	690
132/37	M2BA 315 SMB	3570/1784	94.6/94.1	0.89/0.76	205/67	6.6/5.2	353/197	1.2/1.5	2.6/2.5	1.4	920
178/44	M2BA 315 MLA	3570/1784	95.1/94.6	0.89/0.77	285/83	7.2/5.5	476/235	1.5/1.6	2.7/2.5	2.1	1170
220/52	M2BA 355 S	3585/1790	94.5/93.7	0.85/0.75	360/97	7.5/5.5	586/277	1.5/1.4	2.3/2.1	4.2	1550
230/58	M2BA 355 SMA	3585/1790	94.5/94.2	0.85/0.77	375/105	7.0/6.0	612/309	1.7/1.7	2.5/2.3	5.3	1750
	M2BA 355 MLA										
	M2BA 400 M										
	M2BA 400 LKA										

# Technical data

## Marine motors with cast iron frame, two speed

IP 55 - IC 411 - Temperature rise 90 K

Output kW	Motor type	Product code	Speed r/min	Efficiency %	Power factor cos φ	Current		Torque									
						$I_N$ A	$I_s$ A	$T_N$ Nm	$T_s$ Nm	$T_{max}$ Nm							
<b>1500/1000 r/min = 4/6 poles</b>						<b>380 V 50 Hz</b>						<b>Fan drive, two separate windings</b>					
9.2/3.1	M3BP 160 M	3GBP 168354-••A	1460/970	86.6/74.0	0.83/0.76	19.5/8.5	6.5/4.0	60/60	2.0/1.2	2.5/1.7							
12/7	M3BP 160 L	3GBP 168355-••A	1460/970	88.1/75.7	0.83/0.74	26.5/11	7.1/4.5	83/83	2.3/1.4	2.7/1.9							
14/4.4	M3BP 180 M	3GBP 188359-••A	1470/980	88.7/76.5	0.83/0.72	29/12	6.5/4.5	91/91	1.9/1.3	2.5/2.0							
17.6/5.7	M3BP 180 L	3GBP 188360-••A	1470/980	89.7/78.5	0.83/0.73	36/15	6.8/4.5	114/114	2.0/1.3	2.6/1.9							
20/6.3	M3BP 200 MLA	3GBP 208213-••A	1475/985	89.5/84.0	0.88/0.87	39/13.8	8.0/8.0	129/129	1.7/2.0	2.9/3.0							
26/7.9	M3BP 200 MLB	3GBP 208214-••A	1470/985	90.0/83.5	0.90/0.89	49/16.6	8.0/6.9	169/169	1.7/1.2	2.8/2.2							
31/11	M3BP 225 SMB	3GBP 228209-••A	1470/985	91.0/85.0	0.91/0.89	58/22	7.6/6.0	201/201	1.5/1.2	2.7/2.1							
37/12.3	M3BP 225 SMC	3GBP 228210-••A	1475/985	91.5/89.0	0.89/0.89	70/25	8.6/7.0	240/240	1.7/1.4	3.1/2.4							
55/16.3	M3BP 250 SMB	3GBP 258205-••A	1475/985	93.5/87.0	0.89/0.79	101/37	7.8/7.5	356/356	2.5/3.1	2.8/2.7							
85/27	M2BA 280 SMB	3GBA 288224-••A	1486/990	94.3/90.0	0.85/0.77	163/61	7.5/7.6	546/260	2.4/2.3	2.8/2.8							
95/29	M2BA 280 SMC	3GBA 288234-••A	1485/989	94.6/89.5	0.87/0.80	176/62	7.6/7.0	611/280	2.4/2.9	2.7/2.5							
120/36	M2BA 315 SMB	3GBA 318224-••A	1489/992	95.5/91.7	0.84/0.76	227/80	7.1/6.8	770/347	2.0/2.9	2.7/2.9							
130/39	M2BA 315 SMC	3GBA 318234-••A	1487/991	95.2/91.9	0.86/0.78	242/83	6.2/6.0	835/376	1.8/2.4	2.3/2.5							
150/45	M2BA 315 MLA	3GBA 318414-••A	1485/989	95.4/91.0	0.86/0.78	278/96	6.2/5.2	965/434	1.9/2.1	2.6/2.2							
160/55	M2BA 355 S	3GBA 358104-••A	1482/985	95.0/91.5	0.90/0.84	286/111	5.5/4.7	1031/533	1.2/1.3	2.5/2.0							
240/85	M2BA 355 SMA	3GBA 358214-••A	1486/987	95.5/93.0	0.90/0.85	430/170	7.0/6.0	1542/822	1.3/1.5	2.9/2.4							
315/90	M2BA 355 MLA	3GBA 358414-••A	1493/993	96.2/94.2	0.87/0.83	570/175	8.2/7.1	2014/865	1.2/1.4	3.3/2.7							
315/90	M2BA 400 M	3GBA 408304-••A	1493/993	96.2/94.2	0.87/0.83	570/175	8.2/7.1	2014/865	1.2/1.4	3.3/2.7							
370/120	M2BA 400 LKA	3GBA 408514-••A	1494/993	96.4/95.0	0.85/0.83	690/235	7.6/5.7	2365/1154	1.2/1.2	3.2/2.5							
<b>1500/750 r/min = 4/8 poles</b>						<b>380 V 50 Hz</b>						<b>Fan drive, two separate windings</b>					
7.8/1.2	M3BP 160 M	3GBP 168356-••A	1460/735	86.0/64.0	0.83/0.52	17/5.5	6.5/3.9	51/51	2.0/2.3	2.5/2.6							
11.4/1.6	M3BP 160 L	3GBP 168357-••A	1460/735	87.3/59.0	0.84/0.51	24/8	6.4/3.9	75/75	2.0/1.9	2.4/2.7							
14/2	M3BP 180 M	3GBP 188361-••A	1475/740	89.3/63.6	0.82/0.51	30/9.5	7.2/4.0	92/92	2.2/1.8	2.8/2.7							
16.7/2.4	M3BP 180 L	3GBP 188362-••A	1475/740	90.1/67.5	0.83/0.52	35/10	7.3/3.9	108/108	2.3/1.7	2.8/2.5							
23/2.9	M3BP 200 MLA	3GBP 208216-••A	1475/740	91.0/73.0	0.85/0.59	46/10.2	7.0/4.7	149/149	2.1/2.4	2.5/2.6							
26/3.3	M3BP 200 MLB	3GBP 208217-••A	1470/740	91.5/75.5	0.86/0.59	50/11.4	7.0/4.8	169/169	2.2/2.3	2.5/2.3							
33/4.6	M3BP 225 SMB	3GBP 228211-••A	1480/740	91.5/80.5	0.84/0.63	66/14	7.6/5.3	213/213	2.2/2.3	2.7/2.0							
40/6.2	M3BP 225 SMC	3GBP 228212-••A	1480/740	92.5/82.0	0.86/0.66	78/17.7	8.0/5.0	258/258	2.4/2.1	2.8/2.1							
55/8.8	M3BP 250 SMB	3GBP 258206-••A	1475/740	93.5/83.0	0.89/0.65	101/25	7.8/6.2	356/356	2.5/3.1	2.8/2.8							
85/12	M2BA 280 SMB	3GBA 288222-••A	1486/743	94.3/85.5	0.85/0.64	163/64	7.5/4.9	546/154	2.4/3.0	2.8/2.2							
95/15	M2BA 280 SMC	3GBA 288232-••A	1485/743	94.6/86.5	0.87/0.63	176/42	7.6/5.3	611/193	2.4/2.4	2.7/2.3							
120/16	M2BA 315 SMB	3GBA 318222-••A	1489/740	95.5/87.5	0.84/0.71	227/40	7.1/4.0	770/206	2.0/1.5	2.7/2.0							
130/17	M2BA 315 SMC	3GBA 318232-••A	1487/743	95.2/87.0	0.86/0.66	242/46	6.2/4.5	835/218	1.8/2.0	2.7/2.4							
150/20	M2BA 315 MLA	3GBA 318412-••A	1485/741	95.4/87.9	0.86/0.68	278/53	6.2/4.2	965/258	1.9/1.8	2.6/2.2							
180/30	M2BA 355 S	3GBA 358102-••A	1485/745	94.0/91.0	0.88/0.64	330/78	7.2/5.5	1157/384	1.5/1.9	2.9/2.6							
230/40	M2BA 355 SMA	3GBA 358212-••A	1485/745	95.0/92.0	0.89/0.64	425/104	7.4/5.7	1479/512	1.5/2.0	3.0/2.7							
300/55	M2BA 355 MLA	3GBA 358412-••A	1488/742	95.6/92.7	0.90/0.70	535/125	7.8/6.0	1925/707	1.6/1.7	3.2/2.6							
300/55	M2BA 400 M	3GBA 408302-••A	1488/742	95.6/92.7	0.90/0.70	535/125	7.8/6.0	1925/707	1.6/1.7	3.2/2.6							
400/60	M2BA 400 LKA	3GBA 408512-••A	1492/744	96.6/93.5	0.90/0.72	695/135	6.7/6.2	2560/770	1.0/1.2	2.6/2.6							
520/65	M2BA 400 LKA	3GBA 408522-••A	1490/743	96.7/92.4	0.92/0.77	885/135	7.2/5.7	3332/835	1.1/1.3	2.9/2.3							
<b>1500/750 r/min = 4-8 poles</b>						<b>380 V 50 Hz</b>						<b>Fan drive, Dahlander-connection</b>					
9.2/2	M3BP 160 M	3GBP 168304-••A	1460/730	87.4/76.2	0.82/0.53	19.5/7.5	7.1/3.6	60/60	2.2/1.4	2.8/2.2							
13.6/2.4	M3BP 160 L	3GBP 168305-••A	1460/730	88.1/76.8	0.84/0.49	28.5/9.5	7.0/3.8	89/89	2.2/1.7	2.7/2.5							
14.9/3	M3BP 180 M	3GBP 188307-••A	1470/735	88.8/78.7	0.85/0.55	30.5/10.5	6.5/3.4	97/97	1.7/1.2	2.3/1.9							
19.3/3.9	M3BP 180 L	3GBP 188308-••A	1475/735	90.1/80.0	0.84/0.52	39/14.5	7.1/3.7	125/125	2.2/1.4	2.7/2.2							
26/5.7	M3BP 200 MLA	3GBP 208116-••A	1470/730	90.5/86.0	0.86/0.64	51/15.7	6.9/4.3	169/169	2.2/1.9	2.4/1.9							
29/7	M3BP 200 MLB	3GBP 208117-••A	1475/730	91.5/86.5	0.86/0.64	56/19.3	8.0/4.3	188/188	2.7/2.0	2.7/1.9							
37/8.8	M3BP 225 SMB	3GBP 228111-••A	1480/740	92.0/89.5	0.78/0.61	79/25	8.0/5.1	239/239	2.6/2.3	3.1/2.4							
44/9.7	M3BP 225 SMC	3GBP 228112-••A	1465/735	92.5/89.5	0.87/0.65	84/26	7.5/4.8	287/287	2.3/2.7	2.5/2.0							
53/13.2	M3BP 250 SMB	3GBP 258106-••A	1475/735	93.0/90.0	0.86/0.70	97/31	8.1/4.8	343/343	2.7/2.2	2.8/2.1							
76/18.5	M2BA 280 SMB	3GBA 288229-••A	1485/741	94.0/91.4	0.86/0.65	143/47	7.9/4.9	489/238	2.9/2.5	2.9/2.1							
85/20	M2BA 280 SMC	3GBA 288239-••A	1484/741	94.2/91.7	0.87/0.65	158/51	8.1/4.8	547/258	3.1/2.5	3.0/2.1							
100/23	M2BA 315 SMB	3GBA 318229-••A	1485/742	94.3/92.7	0.87/0.68	185/55	6.5/4.6	643/296	1.6/1.8	2.4/2.3							
145/33	M2BA 315 MLA	3GBA 318419-••A	1486/742	95.0/93.3	0.87/0.67	267/80	7.5/5.0	932/425	2.3/2.2	2.7/2.4							
155/38	M2BA 355 S	3GBA 358109-••A	1490/745	94.5/93.5	0.88/0.77	282/80	8.0/6.5	993/487	1.6/1.4	3.3/2.8							
175/44	M2BA 355 SMA	3GBA 358219-••A	1490/745	95.0/94.0	0.88/0.77	318/93	8.0/6.5	1121/564	1.7/1.4	3.5/2.9							
220/55	M2BA 355 MLA	3GBA 358419-••A	1491/744	95.8/94.7	0.89/0.70	400/130	8.0/4.2	1409/706	1.9/1.2	3.1/2.1							
220/55	M2BA 400 M	3GBA 408309-••A	1491/744	95.8/94.7	0.89/0.70	400/130	8.0/4.2	1409/706	1.9/1.2	3.1/2.1							
	M2BA 400 LKA	3GBA 408519-••A															

<sup>1)</sup> On request.

The two bullets indicate a 2-letter product code supplement for choice of mounting arrangement, and voltage and frequency; see product catalogue for details.

Output kW	Motor type	Speed r/min	Efficiency %	Power factor cos φ	Current		Torque			Moment of inertia J = 1/4GD <sup>2</sup> kgm <sup>2</sup>	Weight kg
					I <sub>N</sub> A	I <sub>s</sub> A	T <sub>N</sub> Nm	T <sub>s</sub> Nm	T <sub>max</sub> Nm		
<b>1800/1200 r/min = 4/6 poles 440 V 60 Hz Fan drive, two separate windings</b>											
10.5/3.6	M3BP 160 M	1760/1170	86.6/74.0	0.83/0.76	19.5/8.5	6.5/4.0	57/29	1.8/1.1	2.5/1.7	0.089	127
14.6/4.6	M3BP 160 L	1760/1170	88.1/75.7	0.83/0.74	26.5/11	7.1/4.5	79/38	2.1/1.3	2.7/1.9	0.119	148
16.1/5.1	M3BP 180 M	1770/1180	88.8/76.5	0.83/0.72	29/12	6.5/4.5	87/41	1.7/1.2	2.5/1.9	0.176	194
20.2/6.6	M3BP 180 L	1770/1180	89.7/78.5	0.83/0.73	36/15	6.8/4.5	109/53	1.8/1.2	2.6/1.9	0.224	207
23/7	M3BP 200 MLA	1775/1185	89.5/84.0	0.88/0.87	39/13.8	8.0/8.1	124/56	1.5/1.9	2.8/3.0	0.45	250
30/9	M3BP 200 MLB	1770/1185	90.0/83.5	0.90/0.89	49/16.6	8.0/6.9	162/73	1.5/1.1	2.7/2.2	0.54	275
36/13	M3BP 225 SMB	1770/1185	91.0/85.0	0.91/0.89	58/22	7.6/6.1	194/105	1.3/1.1	2.6/2.0	0.68	320
43/14	M3BP 225 SMC	1775/1185	91.5/89.0	0.89/0.89	69/25	8.6/7.0	231/113	1.6/1.3	3.0/2.4	0.8	345
64/19	M3BP 250 SMB	1775/1185	93.5/87.0	0.89/0.79	101/37	7.8/7.5	344/153	2.2/2.7	2.7/2.6	0.88	465
98/33	M2BA 280 SMB	1785/1190	94.5/90.0	0.85/0.77	161/62	7.7/8.0	524/265	2.3/3.0	2.9/2.7	1.5	630
110/35	M2BA 280 SMC	1785/1188	94.7/90.4	0.87/0.80	176/64	7.8/7.3	588/281	2.3/2.9	2.7/2.5	1.85	690
138/41	M2BA 315 SMB	1789/1192	95.3/92.0	0.84/0.76	230/79	7.1/7.2	737/328	1.9/3.0	2.7/3.0	2.6	925
150/45	M2BA 315 SMC	1787/1191	95.3/92.3	0.86/0.78	242/82	6.3/6.5	802/361	1.6/2.5	2.3/2.6	2.9	970
165/50	M2BA 315 MLA	1786/1188	95.3/92.0	0.86/0.78	267/90	6.6/6.0	882/402	2.0/2.4	2.8/2.4	3.5	1080
185/63	M2BA 355 S	1782/1185	94.8/91.3	0.90/0.84	285/108	5.5/4.7	991/507	1.1/1.2	2.4/2.0	6.5	1550
275/100	M2BA 355 SMA	1786/1187	95.3/92.8	0.90/0.85	420/165	7.0/6.0	1470/805	1.2/1.4	2.8/2.3	8.2	1800
360/105	M2BA 355 MLA	1793/1193	96.0/94.0	0.87/0.83	565/175	8.2/7.1	1917/840	1.1/1.3	3.2/2.6	10	2100
360/105	M2BA 400 M	1793/1193	96.0/94.0	0.87/0.83	565/175	8.2/7.1	1917/840	1.1/1.3	3.2/2.6	10	2150
425/140	M2BA 400 LKA	1794/1193	96.2/94.8	0.85/0.83	680/230	7.6/5.7	2262/1120	1.1/1.1	3.1/2.4	14	3050
<b>1800/900 r/min = 4/8 poles 440 V 60 Hz Fan drive, two separate windings</b>											
9/1.4	M3BP 160 M	1760/885	86.0/64.0	0.83/0.52	17/5.5	6.5/3.9	51/15	1.7/2.0	2.3/2.5	0.089	127
13.1/1.8	M3BP 160 L	1760/885	87.3/59.0	0.84/0.51	24/8	6.4/3.9	71/19	1.8/1.7	2.4/2.7	0.119	148
16.1/2.3	M3BP 180 M	1775/890	89.3/63.6	0.82/0.51	30/9.5	7.2/4.0	87/25	2.0/1.6	2.8/2.7	0.176	194
19.2/2.8	M3BP 180 L	1775/890	90.1/67.5	0.83/0.52	35/10	7.3/3.9	103/30	2.1/1.5	2.8/2.4	0.224	207
27/3.4	M3BP 200 MLA	1775/890	91.0/73.0	0.85/0.59	46/10.2	7.0/4.7	143/36	1.9/2.2	2.5/2.5	0.28	255
30/3.8	M3BP 200 MLB	1770/890	91.5/75.5	0.86/0.59	50/11.4	7.0/4.8	162/41	2.0/2.0	2.4/2.2	0.34	275
38/5.3	M3BP 225 SMB	1780/890	91.5/80.5	0.84/0.63	66/14	7.6/5.3	205/57	1.9/2.1	2.6/2.3	0.41	330
46/7.2	M3BP 225 SMC	1780/890	92.5/82.0	0.86/0.66	78/17.7	8.0/5.0	248/77	2.1/1.9	2.7/2.1	0.49	355
64/10.2	M3BP 250 SMB	1775/890	93.5/83.0	0.89/0.65	101/25	7.8/6.2	342/109	2.2/2.7	2.7/2.7	0.89	465
98/98	M2BA 280 SMB	1785/893	94.5/86.5	0.85/0.64	161/34	7.7/5.3	524/150	2.3/3.1	2.9/2.9	1.5	630
110/14	M2BA 280 SMC	1785/893	94.7/87.5	0.87/0.64	176/63	7.8/6.5	588/192	2.3/2.4	2.7/2.7	1.85	690
138/18	M2BA 315 SMB	1789/890	95.3/86.0	0.84/0.70	230/39	7.1/4.2	737/193	1.9/1.6	2.7/2.1	2.6	925
150/20	M2BA 315 SMC	1786/893	95.3/87.6	0.86/0.66	242/46	6.3/4.7	802/214	1.6/2.0	2.3/2.5	2.9	970
165/21	M2BA 315 MLA	1786/892	95.3/88.0	0.86/0.66	267/50	6.6/4.6	882/225	2.0/2.0	2.8/2.6	3.5	1080
210/35	M2BA 355 S	1785/895	93.8/90.8	0.88/0.64	335/80	7.2/5.5	1123/373	1.4/1.8	2.8/2.5	6.5	1550
260/45	M2BA 355 SMA	1785/895	94.8/91.8	0.89/0.64	410/100	7.4/5.7	1391/480	1.4/1.8	2.9/2.6	8.2	1800
350/65	M2BA 355 MLA	1788/892	95.4/92.5	0.90/0.70	535/130	7.8/6.0	1869/696	1.5/1.6	3.1/2.5	10	2100
350/65	M2BA 400 M	1788/892	95.4/92.5	0.90/0.70	535/130	7.8/6.0	1869/696	1.5/1.6	3.1/2.5	10	2150
460/70	M2BA 400 LKA	1792/894	96.4/93.3	0.90/0.72	695/135	6.7/6.2	2451/747	0.9/1.1	2.5/2.5	14	3050
600/75	M2BA 400 LKB	1790/893	96.5/92.2	0.92/0.77	885/140	7.2/5.7	3201/802	1.0/1.2	2.8/2.2	15	3150
<b>1800/900 r/min = 4-8 poles 440 V 60 Hz Fan drive, Dahlander-connection</b>											
10.6/2.3	M3BP 160 M	1760/880	87.4/76.2	0.82/0.53	19.5/7.5	7.1/3.6	58/25	2.0/1.3	2.7/2.2	0.089	127
15.6/2.8	M3BP 160 L	1760/880	88.1/76.8	0.84/0.49	28.5/9.5	7.0/3.8	85/30	2.0/1.5	2.7/2.4	0.119	148
17.1/3.5	M3BP 180 M	1770/885	88.8/78.7	0.85/0.55	30.5/10.5	6.5/3.4	92/38	1.5/1.1	2.3/1.8	0.176	194
22.2/4.5	M3BP 180 L	1775/885	90.1/80.0	0.84/0.52	39/14.5	7.1/3.7	119/49	2.0/1.3	2.7/2.2	0.224	207
30/6.6	M3BP 200 MLA	1770/880	90.5/86.0	0.86/0.64	51/15.7	7.0/4.3	162/72	2.0/1.7	2.4/1.9	0.29	255
34/8.1	M3BP 200 MLB	1775/880	91.5/86.5	0.86/0.64	56/19.3	8.0/4.3	183/88	2.4/1.8	2.6/1.9	0.34	275
43/10.2	M3BP 225 SMB	1780/890	92.0/89.5	0.78/0.61	79/25	8.0/5.1	231/109	2.3/2.1	3.0/2.3	0.49	335
51/11.2	M3BP 225 SMC	1765/885	92.5/89.5	0.87/0.65	84/26	7.5/4.8	276/121	2.1/1.8	2.5/2.0	0.49	355
61/15.3	M3BP 250 SMB	1775/885	93.0/90.0	0.86/0.70	97/31	8.1/4.8	328/165	2.4/2.0	2.7/2.0	0.88	465
87/21	M2BA 280 SMB	1784/891	94.0/91.7	0.86/0.65	141/46	8.1/5.1	466/225	2.7/2.7	2.9/2.1	1.5	630
98/23	M2BA 280 SMC	1784/891	94.4/92.3	0.87/0.65	156/51	8.4/5.0	525/247	2.9/2.9	3.0/2.1	1.85	690
115/26	M2BA 315 SMB	1785/892	94.0/92.5	0.87/0.68	184/54	6.5/4.6	615/278	1.5/1.5	2.4/2.3	2.6	925
167/38	M2BA 315 MLA	1786/892	94.8/93.1	0.87/0.67	267/80	7.5/5.0	893/407	2.1/2.1	2.7/2.4	3.5	1080
180/45	M2BA 355 S	1790/895	94.3/93.3	0.88/0.77	285/82	8.0/6.5	960/480	1.5/1.5	3.2/2.7	6.5	1550
200/50	M2BA 355 SMA	1790/895	94.8/93.8	0.88/0.77	315/90	8.0/6.5	1067/533	1.6/1.6	3.4/2.8	8.2	1800
250/65	M2BA 355 MLA	1791/894	95.6/94.5	0.89/0.70	390/130	8.0/4.2	1333/694	1.8/1.1	3.0/2.1	10	2100
250/65	M2BA 400 M	1791/894	95.6/94.5	0.89/0.70	390/130	8.0/4.2	1333/694	1.8/1.1	3.0/2.1	10	2150
	M2BA 400 LKA										

# Technical data

## Marine motors with cast iron frame, two speed

IP 55 - IC 411 - Temperature rise 90 K

Output kW	Motor type	Product code	Speed r/min	Efficiency %	Power factor cos φ	Current		Torque		
						$I_N$ A	$I_s$ $I_N$	$T_N$ Nm	$T_s$ $T_N$	$T_{max}$ $T_N$
<b>3000/1500 r/min = 2/4 poles</b>			<b>380 V 50 Hz</b>		<b>Constant torque, two separate windings</b>					
10.5/5.3	M3BP 160 M	3GBP 168359-**A	2940/1465	87.5/83.8	0.91/0.78	20/12.5	8.1/6.2	34/34	2.2/2.4	2.9/2.5
13.2/6.6	M3BP 160 L	3GBP 168360-**A	2940/1465	89.7/84.5	0.91/0.77	25/16	8.2/6.2	43/43	2.2/2.5	3.0/2.5
15.8/7.9	M3BP 180 L	3GBP 188352-**A	2945/1465	88.9/83.7	0.91/0.77	30/19	7.9/5.3	51/51	2.4/2.1	2.8/2.1
20/11	M3BP 200 MLA	3GBP 208201-**A	2960/1475	90.0/89.0	0.89/0.85	38/22	8.1/7.3	65/65	1.8/2.1	2.9/2.4
26/14	M3BP 200 MLB	3GBP 208202-**A	2960/1475	91.0/90.0	0.90/0.87	48/28	8.5/7.5	84/84	1.9/2.3	3.0/2.6
32/16	M3BP 225 SMB	3GBP 228201-**A	2960/1480	91.5/91.5	0.91/0.76	59/36	8.1/7.3	103/103	2.5/3.9	2.7/2.5
35/18	M3BP 225 SMC	3GBP 228202-**A	2960/1475	92.0/91.5	0.91/0.79	64/39	8.8/6.5	113/113	2.9/3.3	2.9/2.2
44/22	M3BP 250 SMB	3GBP 258201-**A	2965/1485	93.0/93.0	0.91/0.76	80/48	9.1/8.7	142/142	2.2/3.6	3.0/3.0
62/31	M2BA 280 SMB	3GBA 289221-**A	2976/1487	93.4/93.0	0.90/0.78	112/65	6.9/6.6	199/199	1.7/2.6	2.6/2.5
75/38	M2BA 280 SMC	3GBA 289231-**A	2977/1487	94.0/93.3	0.91/0.79	135/79	7.5/6.9	241/244	1.9/2.8	2.8/2.5
90/45	M2BA 315 SMB	3GBA 319221-**A	2980/1488	94.1/94.1	0.89/0.75	163/97	7.3/6.5	288/289	1.9/3.0	3.1/2.7
115/58	M2BA 315 SMC	3GBA 319231-**A	2978/1488	94.5/94.4	0.90/0.76	205/123	6.8/6.5	369/372	1.9/3.1	2.8/2.8
140/70	M2BA 315 MLA	3GBA 319411-**A	2977/1487	94.7/94.7	0.90/0.77	250/146	6.4/6.2	449/449	1.8/3.2	2.6/2.6
160/80	M2BA 355 S	3GBA 359101-**A	2981/1489	94.8/94.8	0.90/0.77	285/170	6.5/5.9	512/513	1.2/1.8	2.9/2.7
200/100	M2BA 355 SMA	3GBA 359211-**A	2975/1492	95.0/94.5	0.92/0.77	350/210	7.1/7.1	642/640	1.2/1.8	3.3/3.5
	M2BA 355 MLA	3GBA 359411-**A								
	M2BA 400 M	3GBA 409301-**A								
	M2BA 400 LKA	3GBA 409511-**A								
<b>3000/1500 r/min = 2-4 poles</b>			<b>380 V 50 Hz</b>		<b>Constant torque, Dahlander-connection</b>					
7.9/5.7	M3BP 160 MA	3GBP 168306-**A	2900/1445	83.0/82.0	0.91/0.71	16/15	4.9/4.2	26/26	1.2/1.7	1.9/1.9
11/7.9	M3BP 160 M	3GBP 168307-**A	2895/1440	85.1/85.1	0.92/0.79	21.5/18	4.9/4.3	36/36	1.3/1.6	1.8/1.7
13.2/9.2	M3BP 160 L	3GBP 168308-**A	2905/1445	86.5/86.2	0.92/0.78	25.5/21	5.5/4.7	43/43	1.4/1.8	2.0/1.9
15.8/10.5	M3BP 180 M	3GBP 188301-**A	2935/1465	88.4/88.1	0.92/0.75	30/24.5	6.9/5.7	51/51	2.0/2.4	2.5/2.4
21/14.9	M3BP 180 L	3GBP 188302-**A	2945/1465	89.9/88.8	0.92/0.74	39/35	8.0/5.8	68/68	2.5/2.6	2.8/2.5
28/21	M3BP 200 MLA	3GBP 208101-**A	2940/1470	89.0/90.5	0.89/0.86	53/41	7.0/6.1	91/91	1.9/2.2	2.5/2.2
34/26	M3BP 200 MLB	3GBP 208102-**A	2950/1470	90.5/91.0	0.84/0.86	69/50	7.0/7.0	110/110	1.8/2.2	2.7/2.4
37/28	M3BP 225 SMB	3GBP 228101-**A	2955/1475	92.5/93.0	0.92/0.88	66/53	7.3/6.7	120/120	1.5/2.0	2.6/2.4
44/35	M3BP 225 SMC	3GBP 228102-**A	2960/1475	92.5/93.0	0.84/0.87	87/65	7.6/7.3	142/142	1.8/2.1	2.9/2.6
60/44	M3BP 250 SMB	3GBP 258101-**A	2940/1475	93.0/93.5	0.93/0.88	105/81	6.8/7.1	195/195	1.5/2.2	2.4/2.6
90/65	M2BA 280 SMB	3GBA 289228-**A	2960/1485	93.2/94.6	0.92/0.86	159/122	6.6/7.9	290/418	1.3/2.3	2.9/3.0
100/70	M2BA 280 SMC	3GBA 289238-**A	2968/1487	93.4/94.6	0.94/0.87	173/129	7.9/9.0	322/450	1.7/2.7	2.9/3.3
115/75	M2BA 315 SMB	3GBA 319228-**A	2970/1484	94.8/94.8	0.88/0.74	210/162	6.5/6.3	370/483	1.3/2.5	2.5/2.5
157/108	M2BA 315 MLA	3GBA 319418-**A	2971/1485	94.8/94.8	0.89/0.76	283/228	7.2/6.5	505/695	1.7/2.7	2.7/2.7
170/125	M2BA 355 S	3GBA 359108-**A	2978/1485	95.0/94.5	0.92/0.75	296/265	7.0/5.0	545/803	1.1/1.2	3.2/2.7
180/150	M2BA 355 SMA	3GBA 359218-**A	2981/1486	95.0/95.5	0.93/0.80	310/295	7.3/5.3	576/963	1.1/1.1	3.2/2.5
220/165	M2BA 355 MLA	3GBA 359418-**A	2983/1489	95.5/95.8	0.90/0.75	390/355	6.5/5.0	704/1058	1.1/1.5	2.9/2.3
220/165	M2BA 400 M	3GBA 409308-**A	2983/1489	95.5/95.8	0.90/0.75	390/355	6.5/5.0	704/1058	1.1/1.5	2.9/2.3
	M2BA 400 LKA	3GBA 409518-**A								

<sup>1)</sup> On request.

The two bullets indicate a 2-letter product code supplement for choice of mounting arrangement, and voltage and frequency; see product catalogue for details.



Output kW	Motor type	Speed r/min	Efficiency %	Power factor cos φ	Current		Torque			Moment of inertia J = 1/4GD <sup>2</sup> kgm <sup>2</sup>	Weight kg
					I <sub>N</sub> A	I <sub>s</sub> A	T <sub>N</sub> Nm	T <sub>s</sub> Nm	T <sub>max</sub> Nm		
<b>3600/1800 r/min = 2/4 poles</b>			<b>440 V 60 Hz</b>		<b>Constant torque, two separate windings</b>						
12/6.1	M3BP 160 M	3540/1765	87.5/83.8	0.91/0.78	20/12.5	8.1/6.2	32/33	2.0/2.2	2.2/2.4	0.055	133
15.2/7.6	M3BP 160 L	3540/1765	89.7/84.5	0.91/0.77	25/16	8.2/6.2	41/41	2.0/2.2	2.2/2.5	0.057	140
18.2/9.1	M3BP 180 L	3545/1765	88.9/83.7	0.91/0.77	30/19	7.9/5.3	49/49	2.2/1.9	2.4/2.1	0.108	200
23/12.7	M3BP 200 MLA	3560/1775	90.0/89.0	0.89/0.85	38/22	8.1/7.3	62/68	1.6/1.9	2.9/2.3	0.29	255
30/16.2	M3BP 200 MLB	3560/1775	91.0/90.0	0.90/0.87	48/28	8.5/7.5	81/87	1.7/2.1	2.9/2.5	0.34	275
37/18.5	M3BP 225 SMB	3560/1780	91.5/91.5	0.91/0.76	59/36	8.1/7.3	99/99	2.2/3.5	2.6/2.4	0.26	335
40/21	M3BP 225 SMC	3560/1775	92.0/91.5	0.91/0.79	64/39	8.8/6.5	107/113	2.6/2.9	2.9/2.1	0.29	355
51/25	M3BP 250 SMB	3565/1785	93.0/93.0	0.91/0.76	80/48	9.1/8.7	137/134	2.0/3.3	2.9/3.0	0.51	465
72/36	M2BA 280 SMB	3575/1786	92.9/93.0	0.91/0.79	113/65	6.9/6.9	192/192	1.5/2.6	2.5/2.6	0.9	630
86/43	M2BA 280 SMC	3577/1787	93.7/93.7	0.91/0.79	134/76	7.7/7.5	230/230	1.8/2.9	2.8/2.6	1.15	690
104/52	M2BA 315 SMB	3580/1788	93.9/93.9	0.89/0.75	163/97	7.3/6.5	277/278	1.9/3.0	3.1/2.7	1.4	920
132/67	M2BA 315 SMC	3578/1788	94.3/94.2	0.90/0.76	205/123	6.8/6.5	352/358	1.9/3.1	2.8/2.8	1.7	1010
160/80	M2BA 315 MLA	3577/1787	94.5/94.5	0.90/0.77	250/146	6.4/6.2	427/427	1.8/3.2	2.6/2.6	2.1	1170
185/92	M2BA 355 S	3581/1789	94.3/94.5	0.90/0.77	285/165	6.5/5.9	493/491	1.1/1.7	2.8/2.6	3.8	1550
230/115	M2BA 355 SMA	3575/1792	94.5/94.2	0.92/0.77	350/210	7.1/7.1	614/613	1.1/1.7	3.2/3.4	4.8	1750
	M2BA 355 MLA										
	M2BA 400 M										
	M2BA 400 LKA										
<b>3600/1800 r/min = 2-4 poles</b>			<b>440 V 60 Hz</b>		<b>Constant torque, Dahlander-connection</b>						
9.1/6.6	M3BP 160 MA	3500/1745	83.0/82.0	0.91/0.71	16/15	4.9/4.2	25/36	1.1/1.5	1.9/1.9	0.039	118
12.7/9.1	M3BP 160 M	3495/1740	85.1/85.1	0.92/0.79	21.5/18	4.9/4.3	35/50	1.2/1.4	1.3/1.6	0.054	133
15.2/10.6	M3BP 160 L	3505/1745	86.5/86.2	0.92/0.78	25.5/21	5.5/4.1	41/58	1.3/1.6	1.4/1.8	0.057	140
18.7/12	M3BP 180 M	3535/1765	88.4/88.1	0.92/0.75	30/24.5	6.9/5.7	51/65	1.7/2.2	1.9/2.4	0.094	194
24.2/17.1	M3BP 180 L	3545/1765	89.9/88.8	0.92/0.74	39/35	8.0/5.8	65/93	2.2/2.3	2.5/2.6	0.108	200
32/24	M3BP 200 MLA	3540/1770	89.0/90.5	0.89/0.86	53/41	7.0/6.1	86/130	1.7/2.0	2.5/2.2	0.29	255
39/30	M3BP 200 MLB	3550/1770	90.5/91.0	0.84/0.86	69/50	7.0/7.1	105/162	1.6/2.0	2.7/2.4	0.34	275
43/32	M3BP 225 SMB	3555/1775	92.5/93.0	0.92/0.88	66/52	7.3/6.7	116/172	1.3/1.8	2.5/2.4	0.42	330
51/40	M3BP 225 SMC	3560/1775	92.5/93.0	0.84/0.87	87/65	7.6/7.3	137/215	1.6/1.9	2.8/2.6	0.49	355
69/51	M3BP 250 SMB	3540/1775	93.0/93.5	0.93/0.88	105/81	6.8/7.1	188/275	1.3/2.0	2.4/2.5	0.88	465
103/75	M2BA 280 SMB	3560/1785	92.9/94.8	0.92/0.86	157/121	6.6/8.0	276/401	1.2/2.1	2.9/3.0	1.5	630
115/80	M2BA 280 SMC	3566/1787	93.0/94.8	0.94/0.87	173/128	7.8/9.2	308/428	1.5/2.6	2.9/3.4	1.85	690
132/86	M2BA 315 SMB	3570/1784	94.6/94.6	0.88/0.74	210/162	6.5/6.3	353/460	1.2/2.3	2.5/2.5	1.4	920
180/124	M2BA 315 MLA	3571/1785	94.6/94.6	0.89/0.76	283/228	7.2/6.5	481/663	1.5/2.4	2.7/2.7	2.1	1170
190/140	M2BA 355 S	3578/1785	94.5/94.2	0.92/0.75	290/260	7.0/5.0	507/749	1.0/1.1	3.1/2.6	4.2	1550
200/170	M2BA 355 SMA	3581/1786	94.5/95.2	0.93/0.80	300/295	7.3/5.3	533/909	1.0/1.0	3.1/2.4	5.3	1750
250/190	M2BA 355 MLA	3583/1789	95.0/95.5	0.90/0.75	385/350	6.5/5.0	666/1014	1.0/1.4	2.8/2.2	6	2150
250/190	M2BA 400 M	3583/1789	95.0/95.5	0.90/0.75	385/350	6.5/5.0	666/1014	1.0/1.4	2.8/2.2	6	2200
	M2BA 400 LKA										

# Technical data

## Marine motors with cast iron frame, two speed

IP 55 - IC 411 - Temperature rise 90 K

Output kW	Motor type	Product code	Speed r/min	Efficiency %	Power factor cos φ	Current		Torque									
						$I_N$ A	$I_s$ A	$T_N$ Nm	$T_s$ Nm	$T_{max}$ Nm							
<b>1500/1000 r/min = 4/6 poles</b>						<b>380 V 50 Hz</b>						<b>Constant torque, two separate windings</b>					
6.6/4.8	M3BP 160 M	3GBP 168361-**-A	1470/970	84.8/80.0	0.79/0.72	14.5/12	7.5/5.0	43/43	2.2/1.7	3.0/2.1							
10/7.4	M3BP 160 L	3GBP 168362-**-A	1470/970	86.7/82.7	0.80/0.71	21/18.5	8.0/5.5	65/65	2.5/2.1	3.1/2.4							
11.4/7	M3BP 180 M	3GBP 188353-**-A	1470/975	87.2/81.4	0.82/0.75	24.5/17.5	6.7/4.5	71/71	1.9/1.4	2.5/1.8							
13.2/8.8	M3BP 180 L	3GBP 188354-**-A	1475/975	88.4/83.1	0.83/0.74	27.5/22	6.7/4.5	86/86	1.9/1.4	2.5/1.9							
16/11	M3BP 200 MLA	3GBP 208204-**-A	1475/985	88.5/86.0	0.91/0.86	31/23	7.7/7.7	104/104	2.1/2.6	2.5/2.6							
20/13	M3BP 200 MLB	3GBP 208205-**-A	1480/985	89.5/86.5	0.89/0.87	38/27	8.1/7.8	129/129	2.4/2.7	2.8/2.6							
22/15	M3BP 200 MLC	3GBP 208206-**-A	1475/980	89.0/85.5	0.87/0.88	44/30	7.9/6.7	142/142	2.4/2.3	2.7/2.2							
28/18	M3BP 225 SMB	3GBP 228203-**-A	1480/985	90.0/89.5	0.88/0.86	53/36	8.9/8.4	181/181	2.4/2.5	2.9/2.8							
32/21	M3BP 225 SMC	3GBP 228204-**-A	1480/985	90.5/90.0	0.88/0.87	62/41	8.5/7.6	206/206	2.2/2.3	2.8/2.6							
44/28	M3BP 250 SMB	3GBP 258202-**-A	1475/985	92.5/90.5	0.89/0.80	82/60	7.7/7.3	285/285	2.4/3.2	2.7/2.7							
63/42	M2BA 280 SMB	3GBA 289224-**-A	1487/989	93.4/92.0	0.87/0.77	120/90	7.4/7.0	406/406	2.3/3.0	2.7/2.4							
72/48	M2BA 280 SMC	3GBA 289234-**-A	1485/988	93.5/92.4	0.87/0.79	136/101	6.9/7.0	463/464	2.2/3.2	2.6/2.4							
80/54	M2BA 315 SMB	3GBA 319224-**-A	1485/990	93.5/93.8	0.87/0.78	150/112	6.0/6.7	515/521	1.6/3.3	2.4/2.9							
100/67	M2BA 315 SMC	3GBA 319234-**-A	1485/989	93.0/93.8	0.87/0.80	187/136	5.6/6.1	643/647	1.6/2.9	2.3/2.5							
125/85	M2BA 315 MLA	3GBA 319414-**-A	1488/989	94.3/94.1	0.87/0.80	232/172	6.6/6.5	802/821	2.0/3.1	2.8/2.5							
135/90	M2BA 355 S	3GBA 359104-**-A	1485/990	94.0/93.5	0.89/0.81	245/183	6.3/6.8	868/868	1.3/1.8	2.8/3.0							
200/130	M2BA 355 SMA	3GBA 359214-**-A	1489/990	95.0/94.5	0.88/0.80	366/263	7.9/7.1	1282/1254	1.4/1.9	3.5/3.1							
250/170	M2BA 355 MLA	3GBA 359414-**-A	1488/988	95.7/95.0	0.90/0.84	440/330	7.6/6.2	1604/1643	1.5/1.5	3.0/2.6							
250/170	M2BA 400 M	3GBA 409304-**-A	1488/988	95.7/95.0	0.90/0.84	440/330	7.6/6.2	1604/1643	1.5/1.5	3.0/2.6							
350/230	M2BA 400 LKA	3GBA 409514-**-A	1494/994	96.2/95.5	0.85/0.82	680/455	7.8/6.2	2237/2209	1.2/1.2	3.3/2.7							
<b>1500/750 r/min = 4/8 poles</b>						<b>380 V 50 Hz</b>						<b>Constant torque, two separate windings</b>					
4.8/2.4	M3BP 160 M	3GBP 168363-**-A	1465/730	83.6/70.1	0.82/0.57	11/9.5	6.5/4.0	31/31	1.8/1.8	2.5/2.3							
7.9/4	M3BP 160 L	3GBP 168364-**-A	1465/730	86.3/72.6	0.82/0.56	17/15	7.0/4.2	52/52	2.1/2.1	2.7/2.4							
12.3/6.2	M3BP 180 L	3GBP 188356-**-A	1475/735	88.1/76.2	0.82/0.56	26/22	7.1/4.0	80/80	2.0/1.8	2.7/2.2							
16/8.3	M3BP 200 MLA	3GBP 208207-**-A	1475/730	89.5/82.5	0.85/0.65	32/24	7.6/4.4	104/104	2.3/1.9	2.6/1.8							
19/9.7	M3BP 200 MLB	3GBP 208208-**-A	1480/735	90.5/83.0	0.84/0.60	38/30	8.8/4.8	123/123	2.7/2.5	3.0/2.3							
25/12.3	M3BP 225 SMB	3GBP 228205-**-A	1480/735	90.0/85.5	0.85/0.61	50/36	7.8/5.0	161/161	2.1/2.5	2.7/2.3							
30/15	M3BP 225 SMC	3GBP 228206-**-A	1480/735	92.0/87.0	0.86/0.66	59/40	8.1/4.9	194/194	2.2/2.3	2.8/2.0							
44/22	M3BP 250 SMB	3GBP 258203-**-A	1480/740	92.5/88.0	0.87/0.60	83/63	8.8/6.2	284/284	2.7/3.6	3.1/3.0							
55/28	M2BA 280 SMB	3GBA 289222-**-A	1486/742	92.9/90.3	0.88/0.64	103/74	7.3/6.3	353/360	1.9/3.3	2.6/2.4							
68/34	M2BA 280 SMC	3GBA 289232-**-A	1486/740	93.4/90.9	0.88/0.69	127/82	7.6/6.0	437/439	2.2/2.9	2.6/2.2							
86/43	M2BA 315 SMB	3GBA 319222-**-A	1488/740	93.8/91.3	0.86/0.69	162/104	6.8/4.8	552/555	1.9/2.6	2.8/2.3							
105/53	M2BA 315 SMC	3GBA 319232-**-A	1488/740	94.0/91.8	0.86/0.66	197/133	6.7/4.8	674/684	2.0/2.8	2.9/2.3							
160/80	M2BA 355 S	3GBA 359102-**-A	1487/740	94.5/93.0	0.88/0.73	295/180	7.4/4.8	1027/1032	1.4/1.3	3.2/2.0							
180/90	M2BA 355 SMA	3GBA 359212-**-A	1487/742	95.0/94.0	0.88/0.74	330/200	7.6/4.9	1156/1158	1.5/1.4	3.3/2.3							
250/125	M2BA 355 MLA	3GBA 359412-**-A	1488/740	95.3/94.0	0.88/0.73	450/285	8.8/5.4	1604/1613	1.7/1.5	3.6/2.2							
250/125	M2BA 400 M	3GBA 409302-**-A	1488/740	95.3/94.0	0.88/0.73	450/285	8.8/5.4	1604/1613	1.7/1.5	3.6/2.2							
320/160	M2BA 400 LKA	3GBA 409512-**-A	1492/745	96.0/95.3	0.88/0.70	575/365	7.2/6.4	2048/2051	1.1/1.4	2.9/2.7							
<b>1500/750 r/min = 4-8 poles</b>						<b>380 V 50 Hz</b>						<b>Constant torque, Dahlander-connection</b>					
7/4	M3BP 160 M	3GBP 168309-**-A	1440/725	84.1/76.1	0.86/0.60	15/13.5	4.6/3.4	46/46	1.3/1.3	1.8/1.8							
10.5/6.2	M3BP 160 L	3GBP 168310-**-A	1445/725	86.5/78.4	0.86/0.59	21.5/20.5	5.2/3.5	69/69	1.5/1.4	2.0/1.9							
14/7	M3BP 180 L	3GBP 188304-**-A	1460/730	88.4/79.8	0.86/0.54	28.5/25	4.8/3.5	92/92	1.2/1.4	1.8/2.0							
19/11	M3BP 200 MLA	3GBP 208107-**-A	1475/735	87.5/86.0	0.81/0.69	41/29	6.8/6.3	123/123	2.1/2.7	2.7/2.9							
22/13	M3BP 200 MLB	3GBP 208108-**-A	1475/735	89.0/86.0	0.86/0.67	44/35	7.8/6.2	142/142	2.3/2.7	2.8/2.8							
26/15	M3BP 200 MLC	3GBP 208109-**-A	1475/735	90.0/88.0	0.91/0.75	49/35	7.2/6.2	168/168	2.2/2.7	2.4/2.5							
31/19	M3BP 225 SMB	3GBP 228105-**-A	1475/735	90.0/89.0	0.90/0.74	59/45	6.8/5.8	201/201	1.7/2.1	2.2/2.3							
37/22	M3BP 225 SMC	3GBP 228106-**-A	1475/735	91.0/89.5	0.91/0.75	69/50	7.0/6.1	240/240	1.8/2.2	2.3/2.3							
48/29	M3BP 250 SMB	3GBP 258103-**-A	1480/740	92.0/90.5	0.90/0.75	89/66	7.5/6.6	310/310	2.2/2.6	2.6/2.6							
65/40	M2BA 280 SMB	3GBA 289229-**-A	1483/742	92.9/92.5	0.89/0.72	120/92	7.0/6.7	419/515	1.9/2.7	2.5/2.5							
78/50	M2BA 280 SMC	3GBA 289239-**-A	1487/742	93.9/93.0	0.89/0.71	142/114	8.4/7.3	501/643	2.4/2.9	2.9/2.6							
86/58	M2BA 315 SMB	3GBA 319229-**-A	1486/742	93.9/93.8	0.90/0.77	155/122	7.0/6.1	553/746	1.2/1.5	2.8/2.5							
135/85	M2BA 315 MLA	3GBA 319419-**-A	1486/742	94.6/94.2	0.90/0.76	241/181	7.2/6.2	868/1094	1.4/1.6	2.8/2.6							
150/90	M2BA 355 S	3GBA 359109-**-A	1490/740	94.0/93.0	0.90/0.74	275/205	6.5/3.4	961/1161	1.2/1.0	2.3/1.9							
180/130	M2BA 355 SMA	3GBA 359219-**-A	1486/740	95.0/94.0	0.89/0.73	325/300	6.4/4.2	1156/1677	1.5/1.3	2.6/2.1							
210/160	M2BA 355 MLA	3GBA 359419-**-A	1488/741	95.3/94.5	0.90/0.7	375/375	7.8/5.0	1347/2062	1.8/1.3	3.3/2.5							
210/160	M2BA 400 M	3GBA 409309-**-A	1488/741	95.3/94.5	0.90/0.7	375/375	7.8/5.0	1347/2062	1.8/1.3	3.3/2.5							
250/185	M2BA 400 LKA	3GBA 409519-**-A	1492/744	96.0/94.8	0.87/0.6	455/510	7.5/4.0	1600/2374	2.2/1.8	3.0/2.0							
330/200	M2BA 400 LKB	3GBA 409529-**-A	1491/744	96.2/95.2	0.9/0.67	580/480	7.4/6.0	2113/2567	1.3/1.4	3.2/2.9							

<sup>1)</sup> On request.

The two bullets indicate a 2-letter product code supplement for choice of mounting arrangement, and voltage and frequency; see product catalogue for details.

Output kW	Motor type	Speed r/min	Efficiency %	Power factor cos φ	Current		Torque			Moment of inertia J = 1/4GD <sup>2</sup> kgm <sup>2</sup>	Weight kg	
					I <sub>N</sub> A	I <sub>s</sub> A	T <sub>N</sub> Nm	T <sub>s</sub> Nm	T <sub>max</sub> Nm			
<b>1800/1200 r/min = 4/6 poles</b>					<b>440 V 60 Hz</b>					<b>Constant torque, two separate windings</b>		
7.6/5.5	M3BP 160 M	1770/1170	84.8/80.0	0.79/0.72	14.5/12	7.5/5.0	41/45	2.0/1.5	2.2/1.7	0.089	127	
11.5/8.5	M3BP 160 L	1770/1170	86.7/82.7	0.80/0.71	21/18.5	8.0/5.5	62/69	2.2/1.9	2.5/2.1	0.119	148	
13.1/8.1	M3BP 180 M	1770/1175	87.2/81.4	0.82/0.75	24.5/17.5	6.7/4.5	71/66	1.6/0.8	1.8/0.9	0.176	194	
15.2/10.1	M3BP 180 L	1775/1175	88.4/83.1	0.83/0.74	27.5/22	6.7/4.5	82/82	1.7/1.3	1.9/1.4	0.224	207	
19/13	M3BP 200 MLA	1775/1185	88.5/86.0	0.91/0.86	31/23	7.7/7.7	102/105	1.8/2.3	2.4/2.5	0.43	260	
23/15	M3BP 200 MLB	1780/1185	89.5/86.5	0.89/0.87	38/27	8.1/7.8	123/121	2.2/2.4	2.7/2.5	0.49	275	
25/17	M3BP 200 MLC	1775/1180	89.0/85.5	0.87/0.88	44/30	7.9/6.7	135/138	2.2/2.1	2.6/2.2	0.49	275	
32/21	M3BP 225 SMB	1780/1185	90.0/89.5	0.88/0.86	53/36	8.9/8.4	172/169	2.2/2.2	2.9/2.7	0.64	320	
37/24	M3BP 225 SMC	1780/1185	90.5/90.0	0.88/0.87	62/41	8.5/7.6	199/194	2.0/2.1	2.7/2.6	0.75	345	
51/32	M3BP 250 SMB	1775/1185	92.5/90.5	0.89/0.80	82/60	7.7/7.3	275/258	2.1/2.9	2.6/2.7	0.88	465	
72/48	M2BA 280 SMB	1786/1188	93.4/92.5	0.86/0.78	119/88	7.5/7.6	385/386	2.2/3.2	2.7/2.5	1.5	630	
83/55	M2BA 280 SMC	1785/1188	93.7/93.0	0.87/0.79	134/99	7.1/7.6	444/142	2.1/3.3	2.6/2.5	1.85	690	
92/62	M2BA 315 SMB	1785/1190	93.3/93.6	0.87/0.78	150/112	6.0/6.7	492/497	1.5/3.0	2.4/2.9	2.6	925	
115/77	M2BA 315 SMC	1785/1189	93.4/93.6	0.87/0.80	187/136	5.6/6.1	615/618	1.5/2.6	2.3/2.5	2.9	970	
144/97	M2BA 315 MLA	1788/1189	94.1/93.9	0.87/0.80	232/172	6.6/6.5	767/787	1.8/2.7	2.8/2.5	3.5	1080	
155/100	M2BA 355 S	1785/1190	93.8/93.3	0.89/0.81	245/175	6.3/6.8	829/802	1.2/1.7	2.7/2.9	6.5	1550	
230/150	M2BA 355 SMA	1789/1190	94.8/94.3	0.88/0.80	360/260	7.9/7.1	1227/1203	1.3/1.8	3.4/3.0	8.2	1800	
285/200	M2BA 355 MLA	1788/1188	95.5/94.8	0.90/0.84	435/330	7.6/6.2	1522/1607	1.4/1.4	2.9/2.5	10	2100	
285/200	M2BA 400 M	1788/1188	95.5/94.8	0.90/0.84	435/330	7.6/6.2	1522/1607	1.4/1.4	2.9/2.5	10	2150	
400/260	M2BA 400 LKA	1794/1194	96.0/95.3	0.85/0.82	650/440	7.8/6.2	2129/2079	1.1/1.1	3.2/2.6	14	3050	
<b>1800/900 r/min = 4/8 poles</b>					<b>440 V 60 Hz</b>					<b>Constant torque, two separate windings</b>		
5.5/2.8	M3BP 160 M	1765/880	83.6/70.1	0.82/0.57	11/9.5	6.5/4.0	30/30	1.6/1.6	2.5/2.2	0.089	127	
9.1/4.6	M3BP 160 L	1765/880	86.3/72.6	0.82/0.56	17/4.2	7.0/4.2	49/50	1.9/1.9	2.7/2.4	0.119	148	
14.1/7.1	M3BP 180 L	1775/885	88.1/76.2	0.82/0.56	26/22	7.1/4.0	76/77	1.8/1.6	2.7/2.2	0.225	207	
19/9.6	M3BP 200 MLA	1775/880	89.5/82.5	0.85/0.65	32/24	7.6/4.4	102/104	2.0/1.7	2.5/1.8	0.29	255	
22/11.2	M3BP 200 MLB	1780/885	90.5/83.0	0.84/0.60	38/30	8.8/4.8	118/121	2.4/2.2	2.9/2.2	0.34	275	
29/14.2	M3BP 225 SMB	1780/885	90.0/85.5	0.85/0.61	50/36	7.8/5.0	156/153	1.9/2.2	2.6/2.3	0.42	330	
35/17.4	M3BP 225 SMC	1780/885	92.0/87.0	0.86/0.66	58/40	8.1/4.9	188/188	1.9/2.0	2.7/1.9	0.49	355	
51/25	M3BP 250 SMB	1780/890	92.5/88.0	0.87/0.60	83/63	8.8/6.2	274/268	2.4/3.3	3.0/3.0	0.89	465	
64/32	M2BA 280 SMB	1785/892	92.9/91.3	0.88/0.64	104/71	7.4/6.9	342/343	1.8/3.4	2.6/2.5	1.5	630	
78/39	M2BA 280 SMC	1786/890	93.6/91.7	0.88/0.69	124/81	8.0/6.4	417/418	2.1/2.9	2.8/2.3	1.85	690	
99/50	M2BA 315 SMB	1788/890	93.6/91.1	0.86/0.69	162/104	6.8/4.8	529/536	1.7/2.4	2.8/2.3	2.6	925	
120/61	M2BA 315 SMC	1788/890	93.8/91.6	0.86/0.66	197/133	6.7/4.8	641/654	1.8/2.5	2.9/2.3	2.9	970	
180/90	M2BA 355 S	1787/890	94.3/92.8	0.88/0.73	285/175	7.4/4.8	962/965	1.3/1.2	3.1/2.0	6.5	1550	
210/105	M2BA 355 SMA	1787/892	94.8/93.8	0.88/0.74	330/200	7.6/4.9	1122/1124	1.4/1.3	3.2/2.2	8.2	1800	
290/140	M2BA 355 MLA	1788/890	95.1/93.8	0.88/0.73	455/270	8.8/5.4	1549/1502	1.6/1.4	3.5/2.1	10	2100	
290/140	M2BA 400 M	1788/890	95.1/93.8	0.88/0.73	455/270	8.8/5.4	1549/1502	1.6/1.4	3.5/2.1	10	2150	
370/180	M2BA 400 LKA	1792/895	95.8/95.1	0.88/0.70	575/355	7.2/6.4	1972/1920	1.0/1.3	2.8/2.6	14	3050	
<b>1800/900 r/min = 4-8 poles</b>					<b>440 V 60 Hz</b>					<b>Constant torque, Dahlander-connection</b>		
8/4.6	M3BP 160 M	1740/875	84.1/76.1	0.86/0.60	15/13.5	4.6/3.4	44/50	1.2/1.2	1.8/1.8	0.089	127	
12.1/7.1	M3BP 160 L	1745/875	86.5/78.4	0.86/0.59	21.5/20.5	5.2/3.5	66/78	1.3/1.3	2.0/1.9	0.119	148	
16.1/8	M3BP 180 L	1760/880	88.4/79.8	0.86/0.54	28.5/25	4.8/3.5	87/87	1.1/1.3	1.8/2.0	0.224	207	
22/12.7	M3BP 200 MLA	1775/885	87.5/86.0	0.81/0.69	41/28	6.8/6.3	118/137	1.9/2.4	2.6/2.8	0.37	245	
25/15	M3BP 200 MLB	1775/885	89.0/86.0	0.86/0.67	44/35	7.8/6.3	135/162	2.1/2.4	2.8/2.7	0.43	260	
30/17.4	M3BP 200 MLC	1775/885	90.0/88.0	0.91/0.75	49/35	7.3/6.2	161/188	2.0/2.4	2.3/2.4	0.49	275	
36/22	M3BP 225 SMB	1775/885	90.0/89.0	0.90/0.74	59/45	6.8/5.8	194/238	1.5/1.9	2.1/2.2	0.64	320	
43/25	M3BP 225 SMC	1775/885	91.0/89.5	0.91/0.75	69/50	7.0/6.1	231/270	1.6/2.0	2.2/2.3	0.75	345	
56/34	M3BP 250 SMB	1780/890	92.0/90.5	0.90/0.75	89/66	7.6/6.6	301/365	1.9/2.3	2.5/2.5	1.49	460	
74/46	M2BA 280 SMB	1784/892	93.1/93.0	0.89/0.73	119/90	7.1/7.0	401/492	1.8/2.6	2.5/2.5	2.2	610	
90/58	M2BA 280 SMC	1786/892	93.9/93.5	0.90/0.73	140/113	8.6/7.6	481/621	2.3/2.9	2.9/2.6	2.85	690	
99/67	M2BA 315 SMB	1784/892	93.7/93.6	0.90/0.77	155/122	7.0/6.1	530/717	1.1/1.4	2.8/2.5	4.1	910	
155/98	M2BA 315 MLA	1786/892	94.4/94.0	0.90/0.76	241/181	7.2/6.2	829/1049	1.3/1.4	2.8/2.6	5.8	1100	
170/100	M2BA 355 S	1790/890	93.8/92.8	0.90/0.74	265/190	6.5/3.4	907/1073	1.1/0.9	2.2/1.9	6.5	1550	
210/150	M2BA 355 SMA	1786/890	94.8/93.8	0.89/0.73	325/290	6.4/4.2	1123/1609	1.4/1.2	2.5/2.0	8.2	1800	
240/180	M2BA 355 MLA	1788/891	95.1/94.3	0.90/0.70	370/360	7.8/5.0	1282/1929	1.7/1.2	3.2/2.4	10	2100	
240/180	M2BA 400 M	1788/891	95.1/94.3	0.90/0.70	370/360	7.8/5.0	1282/1929	1.7/1.2	3.2/2.4	10	2150	
290/210	M2BA 400 LKA	1792/894	95.8/94.6	0.87/0.60	455/490	7.5/4.0	1545/2243	2.0/1.7	2.9/2.0	14	3050	
380/230	M2BA 400 LKB	1791/894	96.0/95.0	0.90/0.67	580/475	7.4/6.0	2026/2457	1.2/1.3	3.1/2.8	15	3150	

# Technical data

## Marine motors, open drip proof motors IP 23S

### IP 23S - IC 411 - Temperature rise 90 K

Output kW	Motor type	Product code	Speed r/min	Effi- ciency %	Power factor cos φ	Current		Torque				
						I <sub>N</sub> A	I <sub>s</sub> I <sub>N</sub>	T <sub>N</sub> Nm	T <sub>s</sub> T <sub>N</sub>	T <sub>max</sub> T <sub>N</sub>		
<b>3000 r/min = 2 poles</b>						<b>380 V 50 Hz</b>						
90	M2FA	250 SA	3GFA	251 110-••A	2955	92.6	0.86	172	5.7	290	1.3	2.0
110	M2FA	250 MA	3GFA	251 310-••A	2958	93.2	0.86	208	6.0	355	1.5	2.2
132	HO	M2FA 250 MB	3GFA	251 320-••A	2961	93.8	0.86	247	6.7	426	1.8	2.4
132	M2FA	280 SMA	3GFA	281 210-••A	2969	94.4	0.86	246	6.5	424	1.6	2.1
160	HO	M2FA 280 MB	3GFA	281 320-••A	2968	94.8	0.88	288	6.7	515	1.8	2.5
160	M2FA	315 SA	3GFA	311 110-••A	2975	94.2	0.87	302	6.4	514	1.5	2.3
200	M2FA	315 SMA	3GFA	311 210-••A	2974	94.3	0.87	370	6.7	644	1.6	2.4
250	M2FA	315 MB	3GFA	311 320-••A	2974	94.4	0.88	449	6.7	804	1.7	2.4
315	M2FA	315 MC	3GFA	311 330-••A	2974	94.6	0.86	576	7.5	1013	1.9	2.6
355	M2FA	315 LA	3GFA	311 510-••A	2965	94.8	0.89	635	6.5	1144	1.8	2.3
400	M2FA	315 LB	3GFA	311 520-••A	2966	94.7	0.88	720	7.0	1290	1.8	2.4
400	M2FA	355 SA	3GFA	351 110-••A	2980	94.6	0.90	700	6.7	1282	1.0	2.4
450	M2FA	355 MA	3GFA	351 310-••A	2975	94.9	0.90	795	7.2	1445	1.2	2.8
500	M2FA	355 MB	3GFA	351 320-••A	2970	95.1	0.90	880	6.5	1608	1.1	2.5
560	M2FA	355 LA	3GFA	351 510-••A	2978	95.5	0.90	980	8.3	1796	1.4	2.8
<b>1500 r/min = 4 poles</b>						<b>380 V 50 Hz</b>						
75	M2FA	250 SA	3GFA	252 110-••A	1469	92.9	0.84	152	5.1	487	1.8	2.1
90	M2FA	250 MA	3GFA	252 310-••A	1470	93.2	0.85	178	5.3	583	1.8	2.2
110	HO	M2FA 250 MB	3GFA	252 320-••A	1468	92.5	0.85	215	5.3	715	1.6	2.2
110	M2FA	280 SA	3GFA	282 110-••A	1474	92.8	0.85	217	5.5	712	1.6	2.2
132	M2FA	280 SMA	3GFA	282 210-••A	1474	93.2	0.86	255	5.7	855	1.6	2.2
160	HO	M2FA 280 MB	3GFA	282 320-••A	1478	93.9	0.84	310	6.8	1033	2.2	2.3
160	M2FA	315 SA	3GFA	312 110-••A	1481	94.5	0.85	306	6.3	1031	1.6	2.1
200	M2FA	315 SMA	3GFA	312 210-••A	1480	94.6	0.85	379	6.0	1287	1.6	2.1
250	M2FA	315 MB	3GFA	312 320-••A	1479	94.7	0.86	470	6.2	1614	1.7	2.3
312	M2FA	315 LA	3GFA	312 510-••A	1475	94.5	0.85	596	6.6	2039	1.8	2.2
355	M2FA	355 SB	3GFA	352 120-••A	1484	95.3	0.84	670	6.0	2285	1.8	2.3
400	M2FA	355 SC	3GFA	352 130-••A	1482	95.2	0.85	746	5.4	2578	1.5	2.0
450	M2FA	355 MA	3GFA	352 310-••A	1483	95.3	0.85	835	6.0	2898	1.6	2.2
500	M2FA	355 LA	3GFA	352 510-••A	1484	95.3	0.84	949	6.9	3218	1.8	2.5
560	M2FA	355 LKD	3GFA	352 540-••A								
750	M2FA	400 LKB	3GFA	402 520-••A								

<sup>1)</sup> On request.

HO = High output design (Cenelec +1)

The two bullets indicate a 2-letter product code supplement for choice of mounting arrangement, and voltage and frequency; see ordering information.

Output kW	Motor type	Speed r/min	Efficiency %	Power factor cos φ	Current		Torque			Moment of inertia $J = \frac{1}{4} GD^2$ kgm <sup>2</sup>	Weight kg
					$I_N$ A	$I_s$ $I_N$	$T_N$ Nm	$T_s$ $T_N$	$T_{max}$ $T_N$		
<b>3600 r/min = 2 poles</b>		<b>440 V 60 Hz</b>									
103	M2FA 250 SA	3556	92.5	0.87	170	5.8	276	1.3	2.0	0.4	360
126	M2FA 250 MA	3559	93.0	0.84	197	6.3	338	1.3	2.0	0.47	395
150	HO M2FA 250 MB	3560	94.2	0.87	238	7.0	402	1.7	2.5	0.56	430
152	M2FA 280 SMA	3568	94.2	0.87	238	6.5	407	1.5	2.3	0.8	540
185	HO M2FA 280 MB	3567	95.0	0.89	286	6.7	495	1.6	2.5	1.15	580
185	M2FA 315 SA	3570	94.3	0.87	300	6.3	495	1.2	2.3	1.2	695
230	M2FA 315 SMA	3570	94.4	0.87	370	6.7	616	1.4	2.4	1.4	770
285	M2FA 315 MB	3571	94.5	0.88	445	6.6	763	1.3	2.3	1.7	840
360	M2FA 315 MC	3574	94.8	0.87	573	7.6	963	1.7	2.6	1.7	840
400	M2FA 315 LA	3568	95.0	0.90	610	6.6	1071	1.6	2.3	2.1	975
460	M2FA 315 LB	3568	94.7	0.89	718	7.1	1233	1.6	2.4	2.1	975
460	M2FA 355 SA	3580	94.2	0.90	690	6.8	1227	1.0	2.4	3.2	1220
520	M2FA 355 MA	3574	94.8	0.90	785	7.3	1389	1.2	2.7	3.5	1320
575	M2FA 355 MB	3570	94.9	0.90	869	6.6	1538	1.0	2.5	3.5	1320
	M2FA 355 LA									4.8	1530
<b>1800 r/min = 4 poles</b>		<b>440 V 60 Hz</b>									
86	M2FA 250 SA	1769	93.5	0.84	146	5.1	464	1.7	2.1	0.6	370
103	M2FA 250 MA	1769	93.6	0.85	174	5.3	556	1.7	2.2	0.72	385
126	HO M2FA 250 MB	1767	93.2	0.86	210	5.3	680	1.5	2.2	0.91	430
126	M2FA 280 SA	1774	93.5	0.85	211	5.6	678	1.5	2.1	1.15	445
152	M2FA 280 SMA	1773	93.8	0.85	251	5.7	818	1.5	2.2	1.4	490
183	HO M2FA 280 MB	1778	94.4	0.85	302	6.8	982	2.1	2.3	1.7	550
184	M2FA 315 SA	1781	95.8	0.86	301	6.4	986	1.5	2.1	2	680
230	M2FA 315 SMA	1782	95.2	0.86	372	6.0	7232	1.5	2.1	2.3	735
287	M2FA 315 MB	1779	95.1	0.86	460	6.2	1540	1.6	2.2	2.9	850
360	M2FA 315 LA	1775	94.6	0.86	589	6.7	1936	1.7	2.2	3.5	970
408	M2FA 355 SB	1783	95.4	0.84	654	6.3	2185	1.8	2.3	5.5	1220
460	M2FA 355 SC	1782	95.1	0.85	744	5.6	2465	1.5	2.0	5.5	1220
500	M2FA 355 MA	1784	95.4	0.86	790	6.1	2677	1.6	2.1	6.5	1350
575	M2FA 355 LA	1784	95.4	0.84	920	7.1	3078	1.6	2.5	7.8	1550
	M2FA 355 LKD									9.8	1820
	M2FA 400 LKB										2700

# Technical data

## Marine motors, open drip proof motors IP 23S

### IP 23S - IC 411 - Temperature rise 90 K

Output kW	Motor type	Product code	Speed r/min	Effi- ciency %	Power factor cos φ	Current		Torque			
						$I_N$ A	$I_s$ $I_N$	$T_N$ Nm	$T_s$ $T_N$	$T_{max}$ $T_N$	
<b>1000 r/min = 6 poles</b>						<b>380 V 50 Hz</b>					
45	M2FA 250 SA	3GFA 253 110-••A	983	90.8	0.83	95	6.7	437	1.5	2.1	
55	M2FA 250 MA	3GFA 253 310-••A	983	91.3	0.85	112	6.5	534	1.5	2.1	
75	HO M2FA 250 MB	3GFA 253 320-••A	983	91.9	0.84	150	6.5	728	1.6	2.3	
75	M2FA 280 SA	3GFA 283 110-••A	985	92.7	0.79	158	5.5	726	1.7	2.0	
90	M2FA 280 SMA	3GFA 283 210-••A	986	92.9	0.79	190	5.9	872	1.8	2.1	
110	HO M2FA 280 MB	3GFA 283 320-••A	986	93.4	0.79	231	6.2	1065	1.9	2.0	
110	M2FA 315 SA	3GFA 313 110-••A	986	93.4	0.85	212	7.1	1064	1.5	2.3	
132	M2FA 315 SMA	3GFA 313 210-••A	986	93.7	0.85	256	7.4	1278	1.6	2.4	
160	M2FA 315 MB	3GFA 313 320-••A	986	94.0	0.85	310	7.9	1547	1.7	2.5	
185	M2FA 315 LA	3GFA 313 510-••A	986	94.2	0.85	352	8.1	1790	1.7	2.6	
200	M2FA 355 SA	3GFA 353 110-••A	989	94.5	0.84	385	6.8	1931	1.5	2.3	
250	M2FA 355 SB	3GFA 353 120-••A	989	94.7	0.84	478	7.0	2414	1.5	2.3	
300	M2FA 355 MA	3GFA 353 310-••A	988	94.9	0.85	546	7.0	2900	1.5	2.3	
<b>750 r/min = 8 poles</b>						<b>380 V 50 Hz</b>					
37	M2FA 250 SB	3GFA 254 120-••A	732	88.5	0.81	80	5.3	482	1.2	2.1	
45	M2FA 250 MB	3GFA 254 320-••A	731	89.3	0.80	98	5.3	587	1.3	2.2	
55	M2FA 280 SA	3GFA 284 110-••A	736	89.9	0.81	119	5.4	713	1.1	1.8	
75	M2FA 280 SMA	3GFA 284 210-••A	736	91.7	0.79	161	5.8	973	1.3	1.9	
90	HO M2FA 280 MB	3GFA 284 320-••A	738	92.5	0.78	192	6.4	1164	1.4	2.0	
90	M2FA 315 SMA	3GFA 314 210-••A	738	92.7	0.80	186	6.5	1164	1.5	2.4	
110	M2FA 315 MB	3GFA 314 320-••A	738	93.2	0.80	233	6.9	1422	1.6	2.5	
132	M2FA 315 LA	3GFA 314 510-••A	737	93.1	0.80	275	6.9	1706	1.6	2.5	
150	M2FA 355 SA	3GFA 354 110-••A	739	93.3	0.77	322	5.1	1938	1.2	1.9	
185	M2FA 355 SB	3GFA 354 120-••A	739	93.7	0.78	393	5.3	2391	1.3	1.9	

<sup>1)</sup> On request.

HO = High output design (Cenelec +1)

The two bullets indicate a 2-letter product code supplement for choice of mounting arrangement, and voltage and frequency; see ordering information.

Output kW	Motor type	Speed r/min	Efficiency %	Power factor cos φ	Current		Torque			Moment of inertia $J = \frac{1}{4} GD^2$ kgm <sup>2</sup>	Weight kg
					$I_N$ A	$I_s$ $I_N$	$T_N$ Nm	$T_s$ $T_N$	$T_{max}$ $T_N$		
<b>1200 r/min = 6 poles</b>		<b>440 V 60 Hz</b>									
52	M2FA 250 SA	1183	91.5	0.84	92	6.6	420	1.4	2.1	1	370
63	M2FA 250 MA	1183	92.1	0.85	109	6.5	512	1.4	2.1	1.2	385
86	HO M2FA 250 MB	1182	92.6	0.85	147	6.6	695	1.5	2.3	1.5	430
86	M2FA 280 SA	1185	93.4	0.80	153	5.5	697	1.6	2.0	1.65	440
103	M2FA 280 SMA	1186	93.7	0.80	183	5.9	829	1.7	2.1	2.6	475
126	HO M2FA 280 MB	1186	94.1	0.80	222	7.0	1011	1.4	2.3	2.9	545
126	M2FA 315 SA	1186	94.0	0.85	205	7.0	1011	1.4	2.3	2.9	630
152	M2FA 315 SMA	1185	94.3	0.86	250	7.4	1214	1.5	2.4	3.8	720
184	M2FA 315 MB	1186	94.5	0.86	300	7.9	1470	1.6	2.6	4.5	810
212	M2FA 315 LA	1186	94.7	0.86	345	8.0	1701	1.6	2.6	5.4	915
230	M2FA 355 SA	1188	94.9	0.84	380	6.8	1849	1.4	2.3	8.7	1220
287	M2FA 355 SB	1188	95.1	0.85	471	7.0	2307	1.4	2.3	10.2	1320
345	M2FA 355 MA	1188	95.1	0.85	553	7.0	2773	1.4	2.3	12.5	1550
<b>900 r/min = 8 poles</b>		<b>440 V 60 Hz</b>									
42	M2FA 250 SB	882	89.7	0.81	78	5.3	454	1.1	2.1	1.2	385
52	M2FA 250 MB	881	90.3	0.80	98	5.3	563	1.2	2.2	1.5	430
63	M2FA 280 SA	886	91.8	0.81	116	5.4	679	1.0	1.8	1.85	460
86	M2FA 280 SMA	886	92.5	0.80	156	5.8	926	1.2	1.9	2.2	500
103	HO M2FA 280 MB	887	93.1	0.79	188	6.4	1108	1.3	2.0	2.9	575
103	M2FA 315 SMA	888	93.3	0.81	186	6.5	1107	1.4	2.4	3.8	720
126	M2FA 315 MB	888	93.8	0.81	226	7.0	1354	1.4	2.5	4.5	810
152	M2FA 315 LA	887	93.7	0.81	271	7.0	1636	1.4	2.5	5.4	915
172	M2FA 355 SA	889	93.9	0.77	320	5.2	1848	1.1	1.9	8.7	1220
212	M2FA 355 SB	889	94.1	0.78	383	5.4	2277	1.2	1.9	10.2	1320

# Dimension drawings

## Marine motors, aluminium and steel frame

### Foot mounted motor IM 1001 / B3

### Flange mounted motor IM 3001 / B5

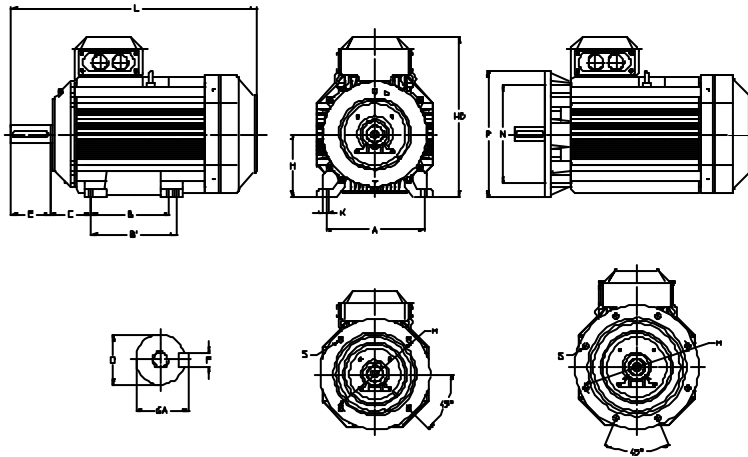

Motor size	IM 1001, B3 and IM 3001, B5										IM 1001, B3						IM 3001, B5				
	D poles		GA poles		F poles		E poles		L max poles		A	B	B'	C	HD	K	H	M	N	P	S
	2	4-8	2	4-8	2	4-8	2	4-8	2	4-8											
<b>Aluminium motors</b>																					
56	9	9	10.2	10.2	3	3	20	20	197	197	90	71	-	36	159	5.8	56	100	80	120	7
63	11	11	16	16	4	4	23	23	205	205	100	80	-	40	171	7	63	115	95	140	10
71	14	14	16	16	5	5	30	30	238	238	112	90	-	45	176	7	71	130	110	160	12
80	19	19	21.5	21.5	6	6	40	40	265	265	125	100	-	50	190	10	80	165	130	200	12
90 S	24	24	27	27	8	8	50	50	295	295	140	100	-	56	212	10	90	165	130	200	12
90 L	24	24	27	27	8	8	50	50	320	320	140	100	-	56	212	10	90	165	130	200	12
100 L	28	28	31	31	8	8	60	60	358.5	358.5	160	140	-	63	236	12	100	215	180	250	15
112 M	28	28	31	31	8	8	60	60	361	361	190	140	-	70	258	12	112	215	180	250	14.5
132 S	38	38	41	41	10	10	80	80	447	447	216	140	178	89	295.5	12	132	265	230	300	14.5
160 <sup>1)</sup>	42	42	45	45	12	12	110	110	602.5	602.5	254	210	254	108	368.5	15	160	300	250	350	19
160 <sup>2)</sup>	42	42	45	45	12	12	110	110	643.5	643.5	254	210	254	108	368.5	15	160	300	250	350	19
180 <sup>3)</sup>	48	48	51.5	51.5	14	14	110	110	680	680	279	241	279	121	403.5	15	180	300	250	350	19
180 <sup>4)</sup>	48	48	51.5	51.5	14	14	110	110	700.5	700.5	279	241	279	121	403.5	15	180	300	250	350	19
200 ML	55	55	59	59	16	16	110	110	773	773	318	267	305	133	496.5	18	200	350	300	400	19
225 SM	55	60	59	64	16	18	110	140	835	865	356	267	311	149	542	18	225	400	350	450	19
250 SMC	60	65	64	69	18	18	140	140	872	872	406	311	349	168	625	22	250	500	450	550	19
<b>Steel motors</b>																					
280 SA	65	75	69	79.5	18	20	140	140	1060	990	457	368	-	190	730	24	280	500	450	550	18
280 MA/SMB	65	75	69	79.5	18	20	140	140	1060	1060	457	368	419	190	730	24	280	500	450	550	18
280 MB	65	75	69	79.5	18	20	140	140	1120	1120	457	419	-	190	730	24	280	500	450	550	18
280 MC	65	75	69	79.5	18	20	140	140	1120	1255	457	406	-	190	730	24	280	500	450	550	18
280 MD	65	75	69	79.5	18	20	140	140	1255	1255	457	406	-	190	730	24	280	500	450	550	18
315 SA	65	80	69	85	18	22	140	170	1095	1125	508	419	-	216	820	28	315	600	550	660	23
315 SMA	65	80	69	85	18	22	140	170	1195	1125	508	419	457	216	820	28	315	600	550	660	23
315 MB	65	80	69	85	18	22	140	170	1195	1225	508	457	-	216	820	28	315	600	550	660	23
315 LA	65	90	69	95	18	25	140	170	1265	1295	508	508	-	216	820	28	315	600	550	660	23
315 LB	65	90	69	95	18	25	140	170	1545	1575	508	508	-	216	820 <sup>9)</sup>	28	315	600	550	660	23
355 SA, SB	70	100	74.5	106	20	28	140	210	1310	1380	610	500	-	254	920	28	355	740	680	800	23
355 MA, MB	70	100	74.5	106	20	28	140	210	1370	1140	610	560	-	254	920	28	355	740	680	800	23
355 LA, LB	70	100	74.5	106	20	28	140	210	1450	1520	610	630	710	254	920	28	355	740	680	800	23
355 LK	-	100	-	106	-	28	-	210	-	1660	610	630	710	254	920	28	355	740	680	800	23
400 ML	70	100	74.5	106	20	28	140	210	1616	1686	686	630	710	280	1003	35	400	740	680	800	23
400 LK	80	100	85	106	22	28	170	210	1786	1826	686	710	800	280	1003	35	400	740	680	800	23

Dimensions are in millimeters.

Above table gives the main dimensions, maximum dimensions for the frame size.

For detailed drawings please see our web-pages [www.abb.com/motors&drives](http://www.abb.com/motors&drives)

or contact ABB motors office.

During the transition period some motor types belonging to M3000 range still have the old product codes and type designations. Always check the valid code before ordering.

<sup>1)</sup> MA2, M2, L2, LB2, M4, L4, LB4, M6, L6, MA8, M8, MA2/4, M2/4, L2/4, M4/6, MA4/8

<sup>2)</sup> LB6, L8, LB8, L4/6, L4/8

<sup>3)</sup> M2, LB2, M4, L4, L6, L8, M2/4, M4/6, M4/8

<sup>4)</sup> LB4, LB6, LB8, L2/4, L4/6, L4/8



# Dimension drawings

## Marine motors, cast iron frame, open drip proof

Foot mounted motor IM 1001 / B3

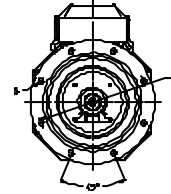
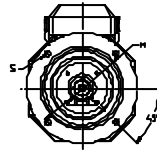
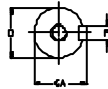
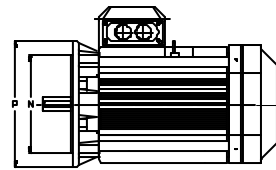
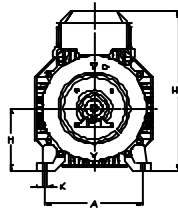
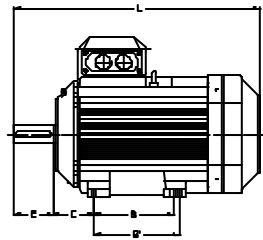

Motor size	IM 1001, B3 and IM 3001, B5										IM 1001, B3						IM 3001, B5					
	D poles		GA poles		F poles		E poles		L max		A	B	B'	C	HD	K	H	M	N	P	S	
	2	4-8	2	4-8	2	4-8	2	4-8	2	4-8	2	4-8	2	4-8	2	4-8	2	4-8	2	4-8		
<b>Cast iron motors</b>																						
<b>71</b>	14	14	16	16	5	5	30	30	255	255	112	90	-	45	186	7	71	130	110	160	10	
<b>80</b>	19	19	21.5	21.5	6	6	40	40	282	282	125	100	-	50	217	10	80	165	130	200	12	
<b>90 S</b>	24	24	27	27	8	8	50	50	310	310	140	100	-	56	235	10	90	165	130	200	12	
<b>90 L</b>	24	24	27	27	8	8	50	50	355	355	140	125	-	56	235	10	90	165	130	200	12	
<b>100</b>	28	28	31	31	8	8	60	60	380	380	160	140	-	63	266	12	100	215	180	250	15	
<b>112</b>	28	28	31	31	8	8	60	60	395	395	190	140	-	70	288	12	112	215	180	250	15	
<b>132 S</b>	38	38	41	41	10	10	80	80	460	460	216	140	-	89	328	12	132	265	230	300	15	
<b>132 M</b>	38	38	41	41	10	10	80	80	500	500	216	178	-	89	328	12	132	265	230	300	15	
<b>160<sup>1)</sup></b>	42	42	45	45	12	12	110	110	602.5	602.5	254	210	-	108	410	14.5	160	300	250	350	18.5	
<b>160<sup>2)</sup></b>	42	42	45	45	12	12	110	110	643.5	643.5	254	254	-	108	410	14.5	160	300	250	350	18.5	
<b>180<sup>3)</sup></b>	48	48	51.5	51.5	14	14	110	110	680	680	279	241	279	121	444	14.5	180	300	250	350	18.5	
<b>180<sup>4)</sup></b>	48	48	51.5	51.5	14	14	110	110	700.5	700.5	279	241	279	121	444	14.5	180	300	250	350	18.5	
<b>200 ML</b>	55	55	59	59	16	16	110	110	774	774	318	267	305	133	494	18.5	200	350	300	400	18.5	
<b>225 ML</b>	55	60	59	64	16	18	110	140	866	866	356	286	311	149	552	18.5	225	400	350	450	18.5	
<b>250 SM</b>	60	65	64	69	18	18	140	140	875	875	406	311	349	168	600	24	250	500	450	550	18.5	
<b>280 SM</b>	65	75	69	79.5	18	20	140	140	1078	1078	457	368	419	190	745	24	280	500	450	550	18	
<b>315 SM</b>	65	80	69	85	18	22	140	170	1174	1204	508	406	457	216	840	30	315	600	550	660	23	
<b>315 ML</b>	65	90	69	95	18	25	140	170	1285	1315	508	457	508	216	840	30	315	600	550	660	23	
<b>355 S</b>	70	100	74.5	106	20	28	140	210	1344	1414	610	500	-	254	955	35	355	740	680	800	23	
<b>355 SM</b>	70	100	74.5	106	20	28	140	210	1396	1466	610	500	560	254	955	35	355	740	680	800	23	
<b>355 ML</b>	70	100	74.5	106	20	28	140	210	1501	1571	610	560	630	254	955	35	355	740	680	800	23	
<b>400 M</b>	70	100	74.5	106	20	28	140	210	1501	1571	686	630	-	280	1005	35	400	740	680	800	23	
<b>400 LKA</b>	80	100	85	106	22	28	170	210	1708	1748	686	710	800	280	1040	35	400	740	680	800	23	
<b>Open drip proof motors</b>																						
<b>250 S</b>	65	75	69	79.5	18	20	140	140	940	940	406	311	-	168	645	24	250	600	550	660	23	
<b>250 MA</b>	65	75	69	79.5	18	20	140	140	940	940	406	349	-	168	645	24	250	600	550	660	23	
<b>250 MB</b>	65	75	69	79.5	18	20	140	140	-	1010	406	349	-	168	645	24	250	600	550	660	23	
<b>280 SA</b>	80	-	85	-	22	-	170	-	1020	457	368	-	190	730	24	280	600	550	660	23		
<b>280 SMA</b>	65	80	69	85	18	22	140	170	1060	1090	457	368	419	190	730	24	280	600	550	660	23	
<b>280 MB</b>	65	80	69	85	18	22	140	170	1120	1150	457	419	-	190	730	24	280	600	550	660	23	
<b>315 SA</b>	70	90	74.5	95	20	25	140	170	1095	1125	508	406	-	216	820	28	315	740	680	800	23	
<b>315 SMA</b>	70	90	74.5	95	20	25	140	170	1195	1125	508	406	457	216	820	28	315	740	680	800	23	
<b>315 MB</b>	70	90	74.5	95	20	25	140	170	1195	1125	508	457	-	216	820	28	315	740	680	800	23	
<b>315 LA, LB</b>	70	90	74.5	95	20	25	140	170	1265	1295	508	508	-	216	820	28	315	740	680	800	23	
<b>355 S</b>	75	100	79.5	106	20	28	140	210	1310	1380	610	500	-	254	920	28	355	740	680	800	23	
<b>355 M</b>	75	100	79.5	106	20	28	140	210	1370	1440	610	560	-	254	920	28	355	740	680	800	23	

Dimensions are in millimeters.  
 Above table gives the main dimensions, maximum dimensions for the frame size.  
 For detailed drawings please see our web-pages 'www.abb.com/motors&drives' or contact ABB motors office.

During the transition period some motor types belonging to M3000 range still have the old product codes and type designations. Always check the valid code before ordering.

- 1) MA2, M2, L2, LB2, M4, L4, LB4, M6, L6, MA8, M8, MA2/4, M2/4, L2/4, M4/6, MA4/8
- 2) LB6, L8, LB8, L4/6, L4/8
- 3) M2, LB2, M4, L6, L8, M2/4, M4/6, M4/8
- 4) L4, LB4, LB6, LB8, L2/4, L4/6, L4/8

# Variant codes

Code	Variant	Aluminium motors					Steel, cast Iron, IP23 motors			
		56-80	90-100	112-132	160-180	200-250	71-132	160-250	280-315	355-400
<b>Balancing</b>										
052	Balancing to Grade R (ISO 2373)	R	P	P	P	P	M	P	P	P
<b>Bearings and Lubrication</b>										
039	Cold resistant grease. For bearing temperatures -55 °C - +100°C.	R	M	M	M	M	M	M	M	M
040	Heat resistant grease. For bearing temperatures -25 - +150 °C.	R	S	S	S	S	M	S	M	M
041	Bearings regreasable via grease nipples.	-	-	M	M	S	-	S	S	S
042	Locked drive end. Standard for M2AA 90 and 100. Standard for M2AA 112-180, flanged versions.	-	M	M	M	S	S	S	S	S
043	SPM nipples.	-	-	M	M	M	M	S	S	S
057	2RS bearings at both ends. Grease for temperature range -20 - +110 °C.	R	M	M	M	M	S	R	-	-
<b>Branch standard design</b>										
178	Stainless steel/acid proof bolts.	R	M	M	M	M	M	P	P	P
<b>Cooling system</b>										
053	Metal fan cover.	S	M	M	S	S	S	S	S	S
054	Special fan for noise reduction.	-	R	-	-	-	-	-	M	M
068	Metal fan.	R	M	M	M	M	M	M	M	M
075	Cooling method IC418 (without fan).	R	M	P	P	P	P	P	P	P
183	Separate motor cooling (fan axial, N-end) (Not available for M2CA and M2FA motors).	R	M	M	M	M	R	P	P	P
422	Separate motor cooling (fan top or side, N-end) (Not available for steel and open drip proof motors).	-	-	-	-	-	-	-	P	P
<b>Dimension drawing</b>										
141	Binding dimension drawing	M	M	M	M	M	M	M	M	M
<b>Drain holes</b>										
066	Modified drain hole position (for specified mounting arrangement). IM designation must be stated.	R	M	M	M	M	M	P	M	M
076	Drain holes with plugs. IM designation must be stated.	S	M	S	S	S	M	S	S	S
<b>Earthing bolt</b>										
067	External earthing bolt "M" for M2CA and M2FA motors.	R	M	M	M	M	M	S	S	S
<b>Heating elements</b>										
450	Heating element, 100-120 V	R	M	M	M	M	M	M	P	P
451	Heating element, 200-240 V	R	M	M	M	M	M	M	M	M
<b>Hazardous environments</b>										
See catalogue 'M3000 Motors for Hazardous Environments' for details.										
<b>Insulation system</b>										
Not available for steel and open drip proof motors.										
014	Winding insulation class H.	-	P	P	P	P	P	P	P	P
405	Special winding insulation for frequency converter supply.	-	R	P	P	P	P	P	P	P

Certain variant codes cannot be used together.  
This list is an extract of a wide range of possible modifications.

- S** = Standard feature.
- M** = Modification of a stocked motor or on new production; the number of motors per order may be limited.
- P** = Only on production.
- R** = On request.
- = Not applicable.

Code	Variant	Aluminium motors					Steel, cast Iron, IP23 motors			
		56-80	90-100	112-132	160-180	200-250	71-132	160-250	280-315	355-400
<b>Mounting arrangements</b>										
007	IM 3001 flange mounted, IEC flange, from IM 1001 (B5 from B3). Large flange with clearance holes.	R	–	–	–	M	–	–	–	–
008	IM 2101 foot/flange mounted, IEC flange, from IM 1001 (B34 from B3). Small flange with tapped holes.	R	M	M	–	–	M	–	–	–
009	IM 2001 foot/flange mounted, IEC flange, from IM 1001 (B35 to B3). Large flange with clearance holes.	R	M	M	M	M	M	M	M	M
047	IM 3601 flange mounted, IEC flange, from IM 3001 (B14 from B5). Small flange with tapped holes.	R	M	M	–	–	M	–	–	–
048	IM 3001 flange mounted, IEC flange, from IM 3601 (B5 from B14). Large flange with clearance holes.	–	M	M	–	–	M	–	–	–
078	(IM 3601) Flange mounted, DIN C-flange. Small flange with tapped holes. Larger flange than standard version.	–	M	–	–	–	–	–	–	–
080	(IM 3001) Flange mounted, DIN A-flange. Large flange with clearance holes. Larger flange than standard version.	–	M	–	–	–	–	–	–	–
090	(IM 2101) foot/flange mounted, DIN C-flange, from IM 1001 (B34 from B3). Small flange with tapped holes. Larger flange than standard version.	–	M	–	–	–	–	–	–	–
091	(IM 2001) foot/flange mounted, DIN A-flange, from IM 1001 (B35 from B3). Large flange with clearance holes. Larger flange than standard version.	–	M	–	–	–	–	–	–	–
<b>Painting</b>										
114	Special paint colour, standard grade.	R	M	M	M	M	M	M	M	M
115	Offshore zink primer painting.	–	–	–	–	–	R	P	R	R
179	Special paint specification.	–	R	R	R	R	R	R	R	R
<b>Protection</b>										
005	Protective roof, vertical motor, shaft down. Vertically mounted motors with shaft extension downwards.	R	M	M	M	M	M	M	M	M
072	Radial seal at D-end.	–	–	M	M	M	M	M	M	M
073	Sealed against oil at D-end.	R	P	–	–	–	M	P	R	R
403	Degree of protection IP56.	–	–	M	M	M	M	M	M	M
404	Degree of protection IP56, without fan. "R" for steel and open drip proof motors.	–	–	P	P	P	M	P	P	P
783	Labyrinth sealing at D-end.	–	–	–	–	–	–	–	M	M
784	Gamma-seal at D-end.	–	–	–	P	P	–	S	M	–
<b>Rating &amp; instruction plates</b>										
098	Stainless rating plate.	R	M	M	M	M	S	S	S	S
161	Additional rating plate delivered loose.	R	M	M	M	M	M	M	M	M
<b>Shaft and rotor</b>										
069	Two shaft extensions as per basic catalogue. Standard shaft material.	–	P	P	P	P	R	P	P	P
070	One or two special shaft extensions, standard shaft material.	–	P	P	P	P	R	P	P	P
164	Shaft extension with closed key-way.	–	S	S	S	S	P	S	P	P
165	Shaft extension with open key-way.	–	P	P	P	P	S	P	S	S
<b>Standards and Regulations</b>										
024	Fulfilling Bureau Veritas (BV) requirements, Essential Service.	–	M	M	M	M	M	M	M	M
025	Fulfilling Det Norske Veritas (DNV) requirements, Essential Service	–	M	M	M	M	M	M	M	M
026	Fulfilling Lloyds Register of Shipping (LR) requirements, Essential Service.	–	M	M	M	M	M	M	M	M

Code	Variant	Aluminium motors					Steel, cast Iron, IP23 motors			
		56-80	90-100	112-132	160-180	200-250	71-132	160-250	280-315	355-400
027	Fulfilling American Bureau of Shipping (ABS) requirements, Essential Service.	-	M	M	M	M	M	M	M	M
096	Fulfilling Lloyds Register of Shipping (LR) requirements, Non-Essential Service.	-	-	-	-	-	-	M	M	M
049	Fulfilling Germanischer Lloyd (GL) requirements, Essential Service.	-	M	M	M	M	M	M	M	M
050	Fulfilling Registro Italiano Navale (RINA) requirements, Essential Service.	-	M	M	M	M	M	M	M	M
051	Fulfilling Russian Maritime Register of Shipping (RS) requirements, Essential Service.	-	M	M	M	M	R	M	M	M
481	Fulfilling Nippon Kaiji Kyokai (NK) requirements, Essential Service.	-	P	M	M	M	R	M	M	M
483	Fulfilling China Classification Societies (CCS) requirements (Beijing), Essential Service.	-	M	M	M	M	R	M	M	M
484	Fulfilling Korea Register of Shipping (KR) requirements, Essential Service.	-	M	M	M	M	R	M	M	M
485	Fulfilling China Corporational Register of Shipping (CR) requirements (Taipei), Essential Service.	-	M	M	M	M	R	M	M	M
491	Fulfilling Nippon Kaiji Kyokai (NK) requirements, Non-Essential Service.	-	M	M	M	M	R	M	M	M
492	Fulfilling Registro Italiano Navale (RINA) requirements, Non-Essential Service.	-	M	M	M	M	M	M	M	M
493	Fulfilling China Classification Societies (CCS) Requirements (Beijing), Non-Essential Service.	-	M	M	M	M	R	M	M	M
494	Fulfilling Korea Register of Shipping (KR) requirements, Non-Essential Service.	-	M	M	M	M	R	M	M	M
495	Fulfilling China Corporational Register of Shipping (CR) requirements (Taipei), Non-Essential Service.	-	M	M	M	M	R	M	M	M
496	Fulfilling Bureau Veritas (BV) requirements, Non-Essential Service.	-	M	M	M	M	M	M	M	M
497	Fulfilling Russian Maritime Register of Shipping (RS) requirements, Non-Essential Service.	-	M	M	M	M	R	M	M	M
152	Classified shaft material.	-	-	P	P	P	R	P	P	P
154	Fulfilling requirements of specified classification society (certificate).	-	-	R	R	R	M	R	M	M

### Stator winding temperature sensors

Breaking capacity for bimetal detector:  
 Alum. 56-100 Alum. 112-250, Steel, cast iron, IP23  
 2 A at 380 V vs 4 A at 250 V vs  
 5 A at 240 V vs 3 A at 60 V Is  
 2.5 A 24 V Is

121	Bimetal detectors, break type (NCC), (3 in series), 130°C, in stator winding.	R	M	M	M	M	R	M	M	M
122	Bimetal detectors, break type (NCC), (3 in series), 150°C, in stator winding.	R	M	M	M	M	R	M	M	M
123	Bimetal detectors, break type (NCC), (3 in series), 170°C, in stator winding.	R	M	M	M	M	R	M	M	M
125	Bimetal detectors, break type (NCC), (2x3 in series), 150°C, in stator winding.	-	M	M	M	M	R	M	M	M
127	Bimetal detectors, break type (NCC), (3 in series, 130 °C & 3 in series, 150 °C), in stator winding.	R	M	M	M	M	R	M	M	M
435	PTC - thermistors (3 in series), 130 °C, in stator winding. Alum. two speed motors, only for new manufacture.	R	M	M	M	M	M	M	M	M

Certain variant codes cannot be used together.  
 This list is an extract of a wide range of possible modifications.

**S** = Standard feature.  
**M** = Modification of a stocked motor or on new production; the number of motors per order may be limited.  
**P** = Only on production.  
**R** = On request.  
**-** = Not applicable.

Code	Variant	Aluminium motors					Steel, cast iron, IP23 motors				
		56-80	90-100	112-132	160-180	200-250	71-132	160-250	280-315	355-400	
436	PTC - thermistors (3 in series), 150 °C, in stator winding. Alum. two speed motors, only for new manufacture.	R	M	M	M	S	M	S	S	S	
437	PTC - thermistors (3 in series), 170 °C, in stator winding. Alum. two speed motors, only for new manufacture.	R	M	M	M	M	M	M	M	M	
439	PTC - thermistors (2x3 in series), 150 °C, in stator winding. Alum. two speed motors, only for new manufacture.	–	M	M	M	M	M	M	M	M	
441	PTC - thermistors (3 in series, 130 °C & 3 in series, 150 °C), in stator winding. Alum. two speed motors, only for new manufacture.	–	M	M	M	M	M	M	M	M	
442	PTC - thermistors (3 in series, 150°C & 3 in series, 170°C), in stator winding. Alum. two speed motors, new manufacture only.	–	–	M	M	M	M	M	M	M	
445	Pt100 (1 per phase) in stator winding. Measurement current max. 10 mA. Temperature: 0 10 20 50 100 150°C Resistance: 100 103.9 107.7 119.3 138.5 158 W	–	–	M	M	M	M	P	M	M	
446	Pt100 (2 per phase) in stator winding. Measurement current max. 10 mA. Temperature: 0 10 20 50 100 150°C Resistance: 100 103.9 107.7 119.3 138.5 158 W	–	–	–	M	M	M	P	M	M	

### Terminal box

015	Δ connection in terminal box (reconnection from Y). Single speed motors only.	–	M	–	–	–	M	M	M	M
017	Y connection in terminal box (reconnection from Δ). Single speed motors only.	–	M	–	–	–	M	M	M	M
019	Larger than standard terminal box. Aluminium motors only for frame sizes 80-250.	–	R	M	M	M	R	R	R	R
021	Terminal box LHS (seen from D-end) (see ordering information page)	R	–	–	–	P	P	P	P	P
023	6 terminals (for Y/D start), single speed, in terminal box		–	S	S	S	M	S	S	S
136	Extended cable connection, standard terminal box. Aluminium motors: 2 m long connection cable.	R	M	R	R	R	M	R	–	–
137	Extended cable connection, low terminal box. Aluminium 63-100: terminal box without screw terminals, 2 m long connection cable. Aluminium motors 112-250: 2 m long flying leads.	R	P	P	P	P	R	R	P	R
413	Extended cable connection, no terminal box.	–	–	–	–	–	R	R	P	P
180	Terminal box RHS (seen from D-end) (see ordering information page)	R	–	–	–	P	P	P	P	P
409	Large terminal box with two terminal blocks.	–	–	–	–	–	R	R	P	P
418	Separate terminal box for temperature detectors.	–	–	M	M	M	M	M	M	P
467	Lower than standard terminal box and rubber extended cable.	–	–	M	M	P	R	P	R	R

### Testing

140	Test confirmation.	R	M	M	M	M	M	M	–	–
145	Type test report from test of identical motor.	R	R	M	M	M	M	M	M	M
146	Type test with report for motor from specific delivery batch.	–	P	M	M	M	M	M	M	M

### Variable speed drives

701	Insulated bearing at N-end.	–	–	–	–	–	–	R	M	M
-----	-----------------------------	---	---	---	---	---	---	---	---	---

# ABB LV Motors' total product offer

## **M2000 range**

<b>Motor type</b>	<b>IEC frame size</b>	<b>Output kW</b>
Aluminium motors	56 - 100	0.055 - 4 kW
Cast iron motors	71 - 315	0.25 - 200 kW

## **M3000 range**

<b>Motor type</b>	<b>IEC frame size</b>	<b>Output kW</b>
Aluminium motors	63 - 250	0.18 - 75 kW
Cast iron motors	71 - 400	0.25 - 710 kW
Steel motors	280 - 400	75 - 630 kW
Hazardous area motors	71 - 400	0.25 - 630 kW
Marine motors	56 - 400	0.06 - 630 kW
Open drip proof motors (IP 23)	250 - 400	75 - 800 kW
Brake motors	63 - 160	0.0055 - 22 kW
	<b>NEMA frame size</b>	<b>Output HP</b>

NEMA motors	444 - 587	75 - 700 HP
-------------	-----------	-------------

### **Special types/alternatives**

- high speed motors, over 3000 r/min
- motor adjusted with a holding brake
- traction motors
- generators for wind mills
- roller tables and mines
- water cooled motors
- slip-ring motors
- motors with vertical hollow shaft
- smoke venting design
- stator/rotor units

Catalogues and brochures for these motors are available from:

ABB Motors  
 Marketing communications  
 P.O.Box 633  
 FIN-65101 Vaasa  
 tel. +358 (0) 10 22 4000  
 fax +358 (0) 10 22 43575  
[www.abb.com/motors&drives](http://www.abb.com/motors&drives)

Visit our web site  
[www.abb.com/motors&drives](http://www.abb.com/motors&drives)

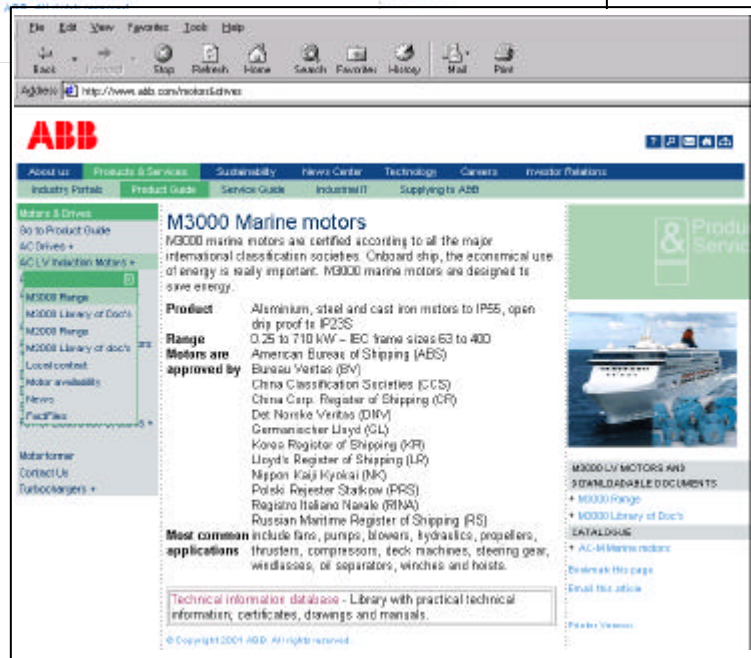
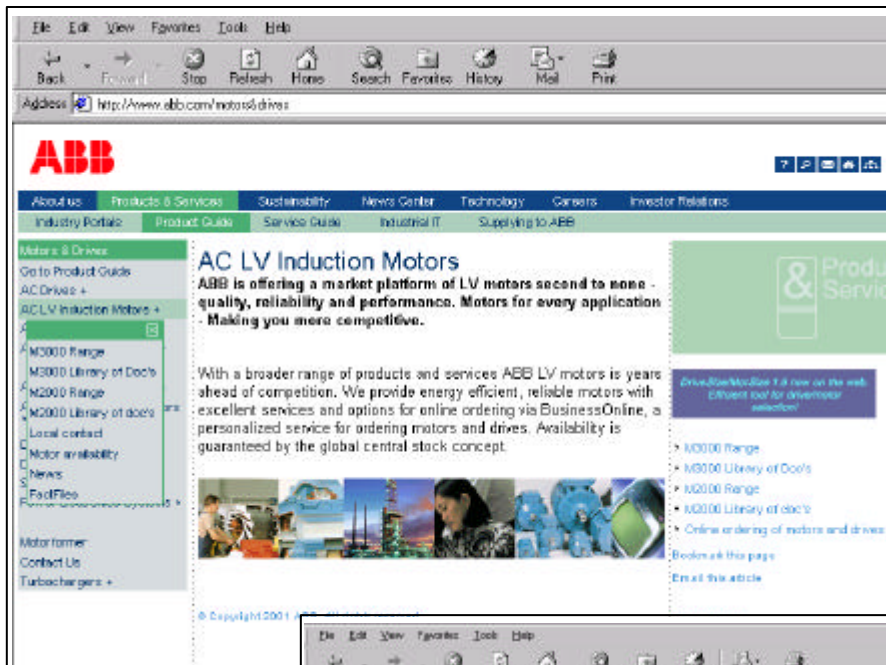

- Motors & Drives**
- AC LV Induction Motors
- M3000 Range
- Standard motors
- Premium efficiency motors
- Process motors
- Hazardous area motors
- Marine motors**
- Brake motors
- Wind turbine generators
- Roller table motors
- Single phase motors
- Fan application motors
- Water-cooled motors
- M3000 Library of documents
- M2000 Range
- M2000 Library of documents
- Local contact
- Motor availability
- News
- FactFiles

# LV Motors

Manufacturing sites (\*) and some of the larger sales companies.

## Australia

ABB Industry Pty Ltd  
2 Douglas Street  
Port Melbourne,  
Victoria, 3207  
Tel: +61 (0) 3 9644 4100  
Fax: +61 (0) 3 9646 9362

## Austria

ABB AG  
Wienerbergstrasse 11 B  
A-1810 Wien  
Tel: +43 (0) 1 601 090  
Fax: +43 (0) 1 601 09 8305

## Belgium

Asea Brown Boveri S.A.-N.V.  
Hoge Wei 27  
B-1930 Zaventem  
Tel: +32 (0) 2 718 6311  
Fax: +32 (0) 2 718 6657

## Brazil

Asea Brown Boveri Ltda  
P.O.Box 00975  
06020-902 Osasco -SP  
Tel: +55 (0) 11 7088 9526  
Fax: +55 (0) 11 7088 4523

## Canada

ABB Inc., BAElectrical Machines  
4410 Paletta Court,  
Burlington, Ontario,  
Canada L7L 5R2  
Tel: +1 905 681 0565  
Fax: +1 905 333 2525

## China\*

ABB Yuejin Motors (Shanghai)  
Company Limited  
8 Guang Xing Rd., Rong Bei  
Town, Songjiang County,  
Shanghai 201613  
Tel: +86 21 5778 0988  
Fax: +86 21 5778 1364

## Chile

Asea Brown Boveri S.A.  
P.O.Box 581-3  
Santiago  
Tel: +56 (0) 2 5447 100  
Fax: +56 (0) 2 5447 405

## Denmark

ABB Motors A/S  
Petersmindevej 1  
DK-5000 Odense C  
Tel: +45 65 477 777  
Fax: +45 65 477 888

## Finland\*

ABB Motors Oy  
P.O.Box 633  
FIN-65101 Vaasa  
Tel: +358 (0) 10 22 4000  
Fax: +358 (0) 10 22 47372

## France

ABB Automation  
Rue du Général de Gaulle  
Champagne-sur-Seine  
F-77811 Moret-sur-Loing Cedex  
Tel: +33 (0) 1 60 746 500  
Fax: +33 (0) 1 60 746 565

## Germany

ABB Automation Products  
GmbH  
P.O.Box 10 02 61  
D-68002 Mannheim  
Tel: +49 (0) 621 3810  
Fax: +49 (0) 621 381 6820

## Hong Kong

ABB Automation Limited  
3 Dai Hei Street  
Tai Po Industrial Estate  
Tai Po New Territories  
Hong Kong  
Tel: +852 292 938 38  
Fax: +852 292 938 87

## India\*

Asea Brown Boveri Ltd  
P.O.Box 16  
Faridabad 121 001  
Tel: +91 (0) 129 5233 313  
Fax: +91 (0) 129 5234 288

## Indonesia

P.T. Abdibangun Buana  
P.O.Box 3781  
Jakarta 10002  
Tel: +62 (0) 21 314 9115  
Fax: +62 (0) 21 315 3963

## Ireland

Asea Brown Boveri Ltd  
Components Division  
Belgard Road  
Tallaght, Dublin 24  
Tel: +353 (0) 1 405 7300  
Fax: +353 (0) 1 405 7327

## Italy\*

ABB Industria S.p.a.  
Motor Division  
Viale Edison 50  
I-20099 Sesto S. Giovanni,  
Milano  
Tel: +39 02 262 321  
Fax: +39 02 262 32723

## Japan

ABB K.K.  
26-1 Cerulean Tower  
Sakuragaoka-cho, Shibuya-ku  
Tokyo 150-8512  
Tel: +81 (0) 3 578 46251  
Fax: +81 (0) 3 578 46260

## Korea

ABB Ltd. Korea  
513, Sungsung-dong,  
Chonan-Si  
Chungchongnam-Do  
Tel: +82 2 528 2327  
Fax: +82 2 546 8517

## Mexico

ABB México, S.A. de C.V.  
Apartado Postal 111  
CP 54000 Tlalnepantla  
Edo. de México, México  
Tel: +52 5 328 1400  
Fax: +52 5 390 3720

## The Netherlands

ABB B.V.  
Dept. LV motors (APP2R)  
P.O.Box 301  
NL-3000 AH Rotterdam  
Tel: +31 (0) 10 4078 879  
Fax: +31 (0) 10 4078 345

## New Zealand

ABB Automation  
Motor Sales  
P.O.Box 22167  
Otahuhu, Auckland  
Tel: +64 (0) 9 276 6016  
Fax: +64 (0) 9 276 1303

## Norway

ABB Industri AS  
P.O.Box 6540 Rodeløkka  
N-0501 Oslo 5  
Tel: +47 22 872 000  
Fax: +47 22 872 541

## Singapore

ABB Industry Pte Ltd  
P.O.Box 95  
Pasir Panjang Post Office  
Singapore 9111  
Tel: +65 775 3777  
Fax: +65 778 0222

## Spain\*

ABB Automation Products, S.A.  
P.O.Box 81  
E-08200 Sabadell  
Tel: +34 93 728 8500  
Fax: +34 93 728 8741

## Sweden\*

ABB Motors AB  
S-721 70 Västerås  
Tel: +46 (0) 21 329 000  
Fax: +46 (0) 21 124 103

## Switzerland

ABB Normelec AG  
Badenerstrasse 790  
Postfach  
CH-8048 Zürich  
Tel: +41 (0) 1 435 6666  
Fax: +41 (0) 1 435 6603

## Taiwan

Asea Brown Boveri Ltd  
P.O.Box 81-54  
Taipei  
Tel: +886 (0) 2 579 9340  
Fax: +886 (0) 2 577 9434

## Thailand

ABB Limited  
5th Building, 322 Moo 4  
Bangpoo Industrial Estate Soi 6  
Sukhumvit Road, Prekasa,  
Muang, Samutprakarn 10280  
Tel: +662 (0) 709 3346  
Fax: +662 (0) 709 3765

## The United Kingdom

ABB Automation Ltd  
9 The Towers, Wilmslow Road  
Didsbury  
Manchester, M20 2AB  
Tel: +44 (0) 161 445 5555  
Fax: +44 (0) 161 448 1016

## USA

ABB Inc.  
Electrical Machines  
P.O.Box 372  
Milwaukee  
WI 53201-0372  
Tel: +1 262 785 3200  
Fax: +1 262 785 8628

## Venezuela

Asea Brown Boveri S.A.  
P.O.Box 6649  
Carmelitas,  
Caracas 1010A  
Tel: +58 (0) 2 238 2422  
Fax: +58 (0) 2 239 6383



## ABB Motors

Marketing Communications  
P.O.Box 633  
FIN-65101 Vaasa Finland  
Tel: +358 (0) 10 22 4000  
Fax: +358 (0) 10 22 43575  
<http://www.abb.com/motors&drives>  
<http://online.abb.com/motors&drives>